



This is a digital copy of a book that was preserved for generations on library shelves before it was carefully scanned by Google as part of a project to make the world's books discoverable online.

It has survived long enough for the copyright to expire and the book to enter the public domain. A public domain book is one that was never subject to copyright or whose legal copyright term has expired. Whether a book is in the public domain may vary country to country. Public domain books are our gateways to the past, representing a wealth of history, culture and knowledge that's often difficult to discover.

Marks, notations and other marginalia present in the original volume will appear in this file - a reminder of this book's long journey from the publisher to a library and finally to you.

### **Usage guidelines**

Google is proud to partner with libraries to digitize public domain materials and make them widely accessible. Public domain books belong to the public and we are merely their custodians. Nevertheless, this work is expensive, so in order to keep providing this resource, we have taken steps to prevent abuse by commercial parties, including placing technical restrictions on automated querying.

We also ask that you:

- + *Make non-commercial use of the files* We designed Google Book Search for use by individuals, and we request that you use these files for personal, non-commercial purposes.
- + *Refrain from automated querying* Do not send automated queries of any sort to Google's system: If you are conducting research on machine translation, optical character recognition or other areas where access to a large amount of text is helpful, please contact us. We encourage the use of public domain materials for these purposes and may be able to help.
- + *Maintain attribution* The Google "watermark" you see on each file is essential for informing people about this project and helping them find additional materials through Google Book Search. Please do not remove it.
- + *Keep it legal* Whatever your use, remember that you are responsible for ensuring that what you are doing is legal. Do not assume that just because we believe a book is in the public domain for users in the United States, that the work is also in the public domain for users in other countries. Whether a book is still in copyright varies from country to country, and we can't offer guidance on whether any specific use of any specific book is allowed. Please do not assume that a book's appearance in Google Book Search means it can be used in any manner anywhere in the world. Copyright infringement liability can be quite severe.

### **About Google Book Search**

Google's mission is to organize the world's information and to make it universally accessible and useful. Google Book Search helps readers discover the world's books while helping authors and publishers reach new audiences. You can search through the full text of this book on the web at <http://books.google.com/>

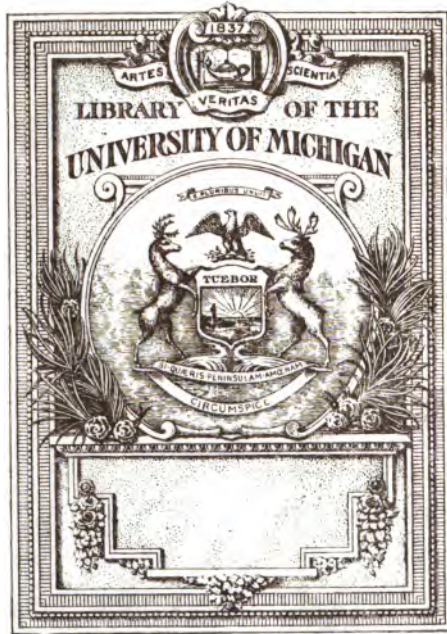

175

PHYSICS LAB.

QC

605

T784

1906

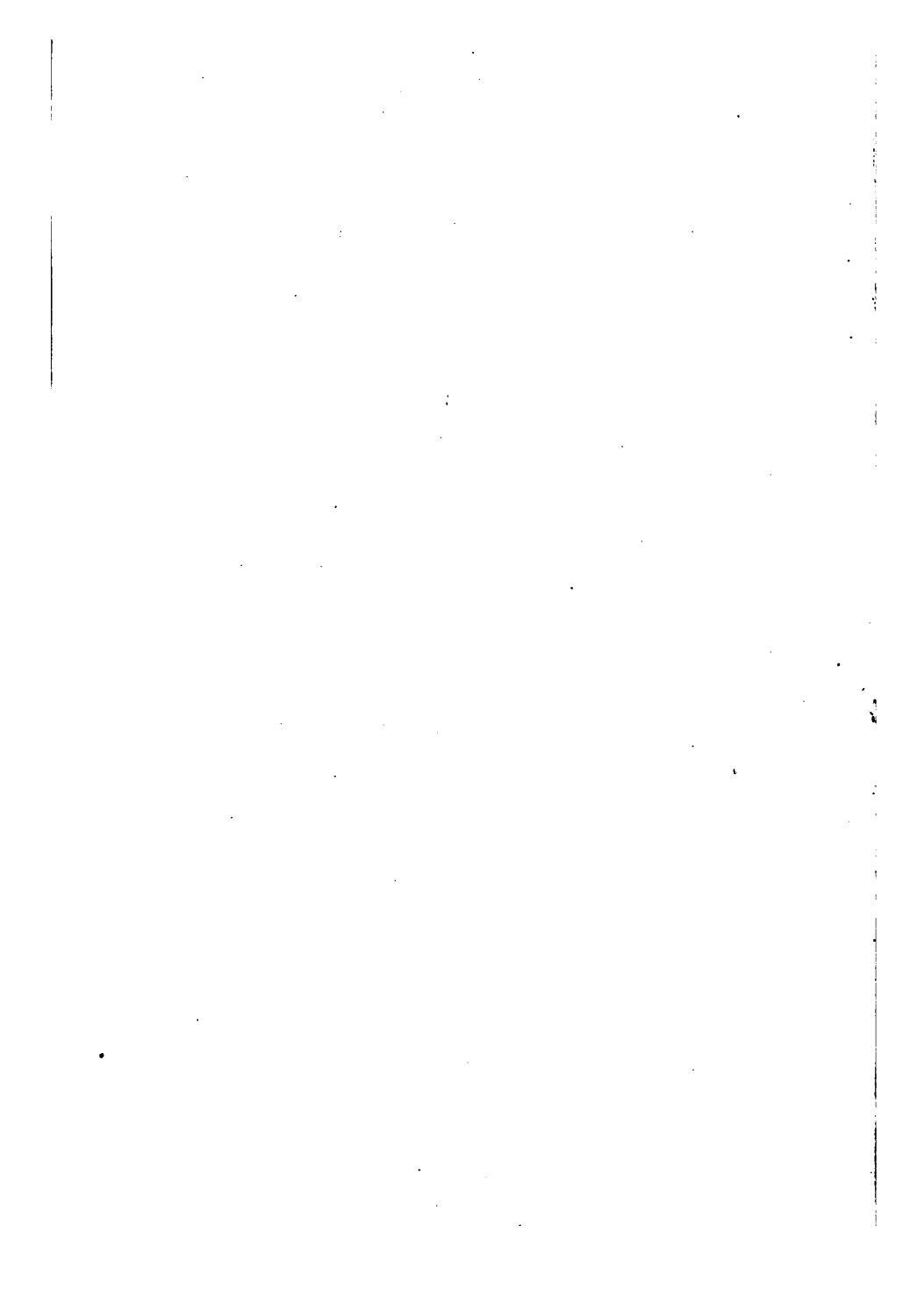

## THE STORAGE BATTERY

•The  Co. •



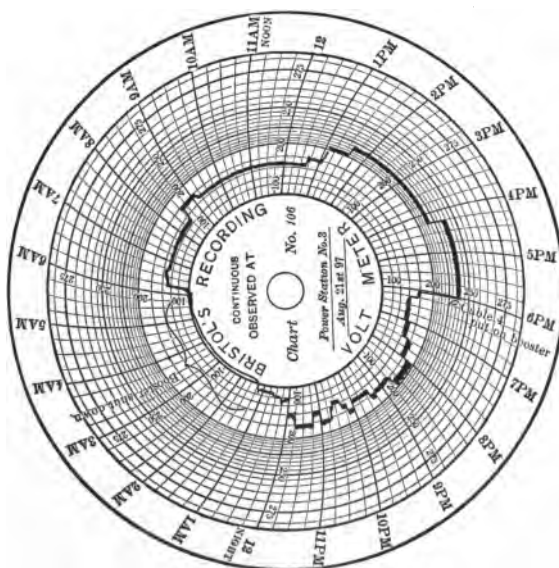
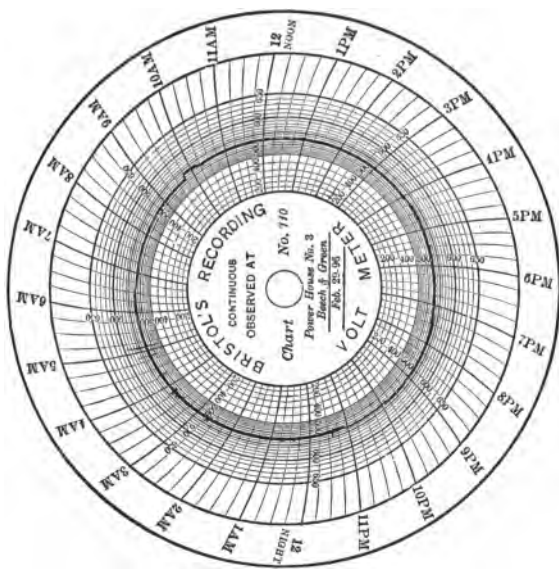

**EFFECT OF STORAGE BATTERIES ON RAILWAY VOLTAGE. — (See page 173).**



THE  
STORAGE BATTERY

A Practical Treatise

ON THE CONSTRUCTION, THEORY, AND USE  
OF SECONDARY BATTERIES



BY

AUGUSTUS TREADWELL, JR., E.E.

ASSOCIATE MEMBER A. I. E. E.

New York

THE MACMILLAN COMPANY

LONDON: MACMILLAN & CO., LTD.

1906

*All rights reserved*



COPYRIGHT, 1898,

By THE MACMILLAN COMPANY.

---

Set up and electrotyped May, 1898. Reprinted January,  
1900; July, 1901; January, October, 1902; December, 1906.

Norwood Press  
J. S. Cushing & Co. — Berwick & Smith  
Norwood Mass. U.S.A.

048178-6

## PREFACE

IN pursuing his work with storage batteries, the author found himself greatly hampered by the lack of any compact data concerning the construction of the many cells which have been, and are on the market, and by the paucity of reliable discharge curves. Believing that a book containing such data and curves, together with rules for the handling and maintenance of cells, would be of great value, not only to the student and manufacturer, but also to all interested in storage batteries, the author began the compilation of the latest and most accurate data concerning the subject. He believes that the list of American and foreign patents, which is given as foot-notes for the various types, will prove of inestimable value to the inventor. It must not be supposed, however, that the list given is at all complete, or that the full list of patents, covering each cell described, is given. So many patents relating to storage batteries have been granted, that a complete list would require a volume of its own; only the principal patents, therefore, have been given for each cell.

The chapter on the chemistry of secondary batteries will be found to give the latest and most generally accepted theory concerning the chemical reactions taking place in an accumulator. This chapter was



048178-6

submitted to, and approved by, a prominent chemist, Dr. Sewal Matheson, whose courtesy the author desires to acknowledge. The table of data, which is to be found in the Appendix, may be relied upon as giving the latest and most accurate figures which could be obtained, of all the batteries. In the Appendix will also be found methods for the measurement of the E.M.F. and internal resistance of a storage battery, also data from which the theoretical and practical capacity of an accumulator may be determined.

The majority of the cuts illustrating Chapter VII., were obtained through the courtesy of Mr. Charles Blizard, of the Electric Storage Battery Co. The author also desires to acknowledge favors extended by the various storage battery companies who have so kindly aided him in the preparation of this work, by freely giving information of every sort, and by furnishing electrotypes. Thanks are also due to Dr. Samuel Sheldon and Mr. John J. Rooney for valuable aid.

AUG. TREADWELL, JR.

NEW YORK, March, 1898.

# INDEX

	PAGE
Accumulators for annex stations . . . . .	145
Accumulators for cold climates . . . . .	237
Accumulator installations :	
Belfast . . . . .	151
Berlin . . . . .	180
Birkenhead . . . . .	153
Boston . . . . .	158
Brooklyn . . . . .	164
Burnley . . . . .	179
Chester . . . . .	148
Chicago Board of Trade . . . . .	180
Commercial Cable Building, New York . . . . .	177
Edinburgh . . . . .	149
Hartford . . . . .	155
Isle of Man — Douglas-Laxey R.R. . . . .	148
Isle of Man — Mt. Snaefel R.R. . . . .	148
Manchester . . . . .	150
Merrill . . . . .	154
New York — Bowling Green . . . . .	161
New York — 12th Street . . . . .	161
New York — 59th Street . . . . .	160
Philadelphia — Philadelphia Edison . . . . .	168
Philadelphia — Union Traction Co. . . . .	173
Rome . . . . .	178
Zurich . . . . .	146
Zurichberg . . . . .	180
Accumulators in place of resistances . . . . .	146
Accumulators in telegraphy . . . . .	184
Albuquerque . . . . .	189
Atlanta . . . . .	187
Baltimore . . . . .	190

	PAGE
<b>Accumulators in telegraphy— <i>Continued</i>:</b>	
Paris . . . . .	189
Washington . . . . .	188
Wilmington . . . . .	190
Accumulator stations in Europe . . . . .	140
Accumulators to act as reservoirs . . . . .	143
Accumulators to carry the peak of the load . . . . .	141
Accumulators to carry the entire load at minimum hours . . . . .	142
Advantages of accumulators during an emergency . . . . .	144
Advantages of overcharging . . . . .	136
Alkaline-zincate genus . . . . .	9, 102
Alternating currents with storage batteries . . . . .	192, 224
Baillache . . . . .	103
Berthelot's discovery of persulphuric acid . . . . .	134
Boiling . . . . .	227
Buckling . . . . .	222
Cadmium plate test . . . . .	239
Capacity, data for the practical calculation of . . . . .	253
Capacities of modern batteries, table of . . . . .	254
Capacity, theoretical calculation of . . . . .	252
Celluloid in accumulator construction . . . . .	239
Central stations, with and without accumulators . . . . .	194
Characteristic curves . . . . .	118
Charging at constant voltage, advantages of . . . . .	223
Charging, hints concerning . . . . .	237
Charge, length of . . . . .	226
Charging, best rate of . . . . .	221, 222
Chemical changes during charge . . . . .	131
Classification of batteries, ordinary . . . . .	8
Classification of batteries, Reynier's . . . . .	8
Color of plates when charged . . . . .	228
Commelin . . . . .	103
Comparison of thick and thin plates . . . . .	129
Conclusions regarding storage battery traction . . . . .	218
Connecting cells . . . . .	235, 245
Cosgrove on measurement of E.M.F. . . . .	249
Cost of construction and operation of electric roads . . . . .	215

# INDEX

ix

	PAGE
Cost of horse and storage battery traction compared . . . . .	200
Cost of overhead and underground trolley systems . . . . .	203
Cost of storage battery installations . . . . .	191
Darrieus on persulphuric acid . . . . .	134
Darrieus' theory . . . . .	134
Data of operation of railways :	
Compressed air line in Paris . . . . .	205
Steam in Belgium . . . . .	206
Steam in Denmark . . . . .	206
Steam in Saxony . . . . .	206
Steam in Paris . . . . .	206
Storage battery in Birmingham . . . . .	208
Storage battery in Paris . . . . .	205
Trolley in Havre . . . . .	205
Trolley in Marseilles . . . . .	206
Defects of lead-sulphuric-acid storage battery . . . . .	115
Definition of primary battery . . . . .	1
Definition of storage battery . . . . .	1
De Virloy . . . . .	103
Description of batteries :	
Acme . . . . .	83
American . . . . .	33
Barber-Starkey . . . . .	80
Barker . . . . .	99
Basset . . . . .	107
Beaumont and Biggs . . . . .	43
Blot . . . . .	92
Boese . . . . .	46
Boettcher . . . . .	25, 99, 105
Brush . . . . .	59, 88
Buckland . . . . .	64
Chloride . . . . .	39
Correns . . . . .	76
Crompton . . . . .	43
Currie . . . . .	37
Darrieus . . . . .	108
D'Arsonval . . . . .	28
De Kabath . . . . .	26

	PAGE
Description of batteries — <i>Continued</i> :	
De Meritens . . . . .	25
Desmazure . . . . .	103
Desruelles . . . . .	47
Drake and Gorham . . . . .	29, 70
Dujardin . . . . .	25
Duncan . . . . .	25, 37
Eickemeier . . . . .	68
Electro-Chemical . . . . .	22
Elwell-Parker . . . . .	16
Engel . . . . .	95
E.P.S. . . . .	66
Epstein . . . . .	17, 100
Erving . . . . .	98
Faure . . . . .	48, 49
Faure-King, E.P.S. traction cell . . . . .	67
Fitzgerald . . . . .	43, 45
Ford-Washburn . . . . .	77
Garassino . . . . .	25
Gaudini . . . . .	29
Gelnhausen . . . . .	95
Gibson . . . . .	74
Grout, Jones, and Sennet . . . . .	89
Gruenwald . . . . .	96
Gülcher . . . . .	84
Hagen . . . . .	50
Haid . . . . .	107
Haschke . . . . .	86
Hatch . . . . .	52
Hauss . . . . .	74
Hering . . . . .	91
Hess . . . . .	82
Hollingshead . . . . .	108
Hough . . . . .	94
Jacquet . . . . .	51, 70
James . . . . .	50, 89
Johnson and Holdregge . . . . .	78
Julien . . . . .	51
Kalischer . . . . .	107



	PAGE
Description of batteries — <i>Continued</i> :	
Khotinsky . . . . .	64
Knowles . . . . .	51
Kowalski . . . . .	85
Krecke . . . . .	94
Lane-Fox . . . . .	35
Lehman . . . . .	108
Lelande-Chaperon . . . . .	102
Lloyd . . . . .	65
Lugo . . . . .	100
Maloney . . . . .	108
Marx . . . . .	105
Mason . . . . .	97
McLaughlin . . . . .	45
Metzger . . . . .	48
Monnier . . . . .	43
Montaud . . . . .	35
Monterd . . . . .	93
Nevins . . . . .	51
New York Accumulator . . . . .	31
Oerlikon . . . . .	90
Ohio Storage Battery . . . . .	30
Paget . . . . .	19, 88
Payen . . . . .	38
Percival . . . . .	44
Peyrusson . . . . .	29
Planté . . . . .	14, 16
Platner . . . . .	106
Pollak . . . . .	44, 63, 89
Pumpelly . . . . .	81
Pumpelly-Sorley . . . . .	35
Reckenzaun . . . . .	90
Remington . . . . .	36
Reynier . . . . .	28, 97, 99
Reynier Elastic . . . . .	79
Ribbe . . . . .	85
River and Rail . . . . .	100
Rooney . . . . .	34, 55, 66
Schaeffer-Heineman . . . . .	95

	PAGE
<b>Description of batteries — <i>Continued</i> :</b>	
Schenek-Farbaky . . . . .	69
Schoop . . . . .	18, 105
Shultz . . . . .	36
Silvey . . . . .	36, 94
Simmen . . . . .	28
Sola-Headland . . . . .	79
Sorley . . . . .	94
Standard . . . . .	30
Starkey . . . . .	25
Sutton . . . . .	97
Tamine . . . . .	100
Tauleigne . . . . .	107
Theryc-Oblasser . . . . .	82
Thompson-Houston . . . . .	102
Tommassi . . . . .	75
Tribe . . . . .	43
Tudor . . . . .	61, 88
Union . . . . .	58
Van Emon . . . . .	55, 66
Van Gestel . . . . .	78
Verdier . . . . .	46
Waddell-Entz . . . . .	104
Willard . . . . .	20
Winkler . . . . .	55
Woodward . . . . .	37, 64
Worms . . . . .	51
Difference of potential between lead-antimony and active material . . . . .	120
Different chemical combinations on positive plate . . . . .	128
Difficulty in making chemical analysis . . . . .	109
Discharge, duration of . . . . .	228
Discharge, duration of, reasons for . . . . .	228
Discharge, effects of too prolonged a . . . . .	225, 228
Distribution of current . . . . .	245
Eating away of lead salts . . . . .	10, 37
Effect of too high a discharge rate . . . . .	129, 230
Efficiency of a storage battery . . . . .	119

# INDEX

xiii

	PAGE
Efficiency of accumulators, average . . . . .	203
Efficiency of accumulator installations . . . . .	194
Elbs and Schönherr on persulphuric acid. . . . .	138
Electric carriages . . . . .	219
Electro-chemical methods of formation . . . . .	10, 16
Electrolysis of a lead salt . . . . .	10, 35
Electrolyte, alteration in the . . . . .	114
Electrolyte, density of . . . . .	238, 240
Electrolyte, purity of . . . . .	235, 241
E.M.F., calculation of, Streintz . . . . .	251
E.M.F., calculation of, Wade . . . . .	250
E.M.F., measurement of, Cosgrove . . . . .	249
E.M.F., measurement of, Negrenau . . . . .	249
End plates . . . . .	243
Examples of storage battery installations . . . . .	146
Faure . . . . .	48, 66, 67
Formation of lead-peroxide on negative electrode . . . . .	127, 130
Forming charge, duration of . . . . .	227
Future improvements . . . . .	245
General theory of storage battery . . . . .	110
Generation of heat due to . . . . .	124
Grassi, measurement of internal resistance . . . . .	248
Griscom and Fitzgerald on active material . . . . .	137
Grooves . . . . .	10, 59
Hanover, mixed system at . . . . .	213
Higher capacity of positives over negatives . . . . .	129
History of the storage battery . . . . .	4
Brush . . . . .	6
Davy . . . . .	5
Erman . . . . .	5
Faraday . . . . .	5
Faure . . . . .	6
Gautherot . . . . .	5
Grove . . . . .	5
Jablochkoff . . . . .	7
Jamins . . . . .	7

	PAGE
History of the storage battery— <i>Continued</i> :	
Marianini . . . . .	5
Maxwell . . . . .	6
Metzger . . . . .	6
Niaudet . . . . .	6
Nicholson and Carlisle . . . . .	5
Planté . . . . .	6
Ritter . . . . .	5
Rue, de la . . . . .	6
Schoenbein . . . . .	5
Sinstedin . . . . .	6
Volta . . . . .	4, 5
Wheatstone . . . . .	5, 6, 98
Improvements in Planté type . . . . .	10, 16
Improvements in Faure type . . . . .	10, 50
Influence of acid on open circuit voltage . . . . .	117
Installations, storage battery . . . . .	140
Installing batteries . . . . .	237
King, E.P.S. patents . . . . .	66, 67
Lead-copper genus . . . . .	9, 97
Lead-sulphuric-acid genus . . . . .	8, 14
Lead-zinc genus . . . . .	9, 98
Life of a storage battery, average . . . . .	204
Losses in a storage battery . . . . .	119
Loss on open circuit . . . . .	120
Mance, measurement of internal resistance . . . . .	248
Manhattan Elevated R. R. . . . .	184
Manufacture of traction cells . . . . .	217
Mechanical improvements . . . . .	10, 25
Method of making copper-oxide electrode . . . . .	102
Miscellaneous cells . . . . .	9, 105
Negrenau on measurement of E.M.F. . . . .	249
Occlusion of hydrogen theory . . . . .	132
Operman's copper-oxide electrode . . . . .	102
Organic matter in active material . . . . .	239

# INDEX

XV

	PAGE
Parker, E.P.S. patents . . . . .	66
Passage of current from one plate to another . . . . .	121
Per cent load factor . . . . .	196
Per cent maximum demand factor . . . . .	196
Perforations . . . . .	11, 66
Perforations, kinds of . . . . .	11, 66, 241
Peroxide plate called positive . . . . .	1
Persulphuric acid theory . . . . .	134, 138
Berthelot . . . . .	134
Elbs and Schönherr . . . . .	138
Robertson and Darrieus . . . . .	134
Planté and Faure types compared . . . . .	48
Plates, construction of . . . . .	241, 243
Potential of a cell due to . . . . .	118
Position of cells . . . . .	234
Preparation of active material . . . . .	94
Prevention of buckling . . . . .	11, 90
Primary and storage batteries compared . . . . .	185
Private plants . . . . .	192
Reason that storage cells are not near perfection . . . . .	109
Recuperation . . . . .	184, 206, 215
Reduction of weight . . . . .	10, 50
by alloys . . . . .	10, 50
by non-conducting grids . . . . .	10, 52
Relation between capacity and discharge rate . . . . .	230
Relation between capacity and specific gravity . . . . .	238
Relation between E.M.F. and acid concentration . . . . .	117
Resistance measurements, Grassi . . . . .	248
Resistance measurements, Mance . . . . .	248
Resistance measurements, Sheldon . . . . .	247
Resistance of a cell, Streintz . . . . .	114
Retaining case made of conducting material . . . . .	11, 75
Retaining case made of non-conducting material . . . . .	11, 79
Retention of paste . . . . .	10, 59
Reynier's classification . . . . .	8
Reversed polarity . . . . .	244
Robertson on chemical theory . . . . .	127
Room, choice of battery . . . . .	233

	PAGE
Salomons, on best rate of charge . . . . .	222
Salomons, on process of charging . . . . .	131
Sellon, E.P.S. patents . . . . .	66
Separators . . . . .	235
Setting up a battery . . . . .	234
Sheldon, measurement of internal resistance . . . . .	247
Solid active material . . . . .	10, 44
Specific resistance of acid . . . . .	114
Spraying . . . . .	236
Storage battery, economy of . . . . .	3
Storage battery traction —	
Berlin . . . . .	210
Birmingham . . . . .	208
Brussels — Tervueren . . . . .	207
Chicago — Englewood . . . . .	212
Dubuque . . . . .	214
Hagen — Vienna . . . . .	208
Hague — Sheveningen . . . . .	211
Hanover . . . . .	213
Madison Avenue, New York City . . . . .	212
Paris . . . . .	206
Streintz, calculation of capacity . . . . .	251
Streintz, theory . . . . .	112
Sulphating . . . . .	241
Superiority of lead-lead over other types . . . . .	11
Swan, James W., originator of perforated plates . . . . .	66
Telegraphy, storage batteries in . . . . .	3, 184
Temperature variations during charge and discharge . . . . .	123
Testing a battery . . . . .	231, 239
Tests of Theryc-Oblasser battery for traction . . . . .	207
Tests of traction systems . . . . .	205
Theoretical energy of lead . . . . .	111
Theory . . . . .	109, 126
Theory of Darrieus . . . . .	112
Theory of primary and storage batteries identical . . . . .	110
Theory of Streintz . . . . .	112
Traction, storage battery . . . . .	4, 198
Traction, storage battery, in Europe and America . . . . .	199

## INDEX

xvii

	PAGE
Transportation of battery after being used . . . . .	244
Trolley and accumulator systems compared . . . . .	214
Trolley roads, disadvantages of . . . . .	199
Uses of accumulators . . . . .	2, 141
Volckmar, E.P.S. patents . . . . .	66
Variation in capacity with temperature . . . . .	125
Wade, calculation of capacity . . . . .	250
Weight of storage battery cars, increased . . . . .	201

---

## ILLUSTRATIONS

### Batteries :

American . . . . .	33
Blot . . . . .	93
Brush . . . . .	60
Chloride . . . . .	40, 41, 42
Correns . . . . .	76
Currie . . . . .	38
De Kabath . . . . .	26
Drake and Gorham . . . . .	70
Eickemeier . . . . .	69
Electro-Chemical . . . . .	23
E.P.S. . . . .	67
Epstein . . . . .	18
Gibson . . . . .	74
Hatch . . . . .	53
Haus . . . . .	71
Hering . . . . .	91
Jacquet . . . . .	74
Khotinsky . . . . .	65
Montaud . . . . .	36
New York accumulator . . . . .	31
Ohio storage battery . . . . .	30
Percival . . . . .	44
Pumpelly-Sorley . . . . .	35
Reckenzaun . . . . .	90

	PAGE
<b>Batteries — <i>Continued</i> :</b>	
Rooney . . . . .	34, 56
Schoop . . . . .	19
Tommassi . . . . .	75
Tudor . . . . .	61
Union . . . . .	58
Willard . . . . .	20, 22
<b>Battery curves :</b>	
Bradbury-Stone . . . . .	75
Chloride . . . . .	43
De Kabath . . . . .	27
Electro-Chemical . . . . .	24
E.P.S. . . . .	68
Ford-Washburn . . . . .	77
Gadot . . . . .	224, 225
Gülcher . . . . .	84
Haschke . . . . .	87
Hatch . . . . .	54
Hauss . . . . .	72, 73
Pollak . . . . .	63
River and Rail . . . . .	101
Rooney . . . . .	57
Tudor . . . . .	62
Willard . . . . .	21
<b>Curves :</b>	
Berlin load curve . . . . .	181
Capacity and specific gravity at close of discharge . . . . .	130
Charging at constant current . . . . .	224
Charging at constant voltage . . . . .	225
Chicago Board of Trade, load curve . . . . .	182
Effect of accumulators on voltage curve, Merrill . . . . .	154, 155
Effect of accumulators on voltage curve, Union Traction Co., Philadelphia . . . . .	Frontispiece, 174
Elevator-load curve . . . . .	183
E.M.F. and per cent of acid . . . . .	116
E.M.F. of charge and discharge compared . . . . .	113
E.M.F. and specific gravity at close of discharge . . . . .	131
Hartford load curve . . . . .	157



# INDEX

xix

	PAGE
<i>Curves — Continued:</i>	
Influence of acid on open-circuit voltage . . . . .	117
Load curve for Union Traction Co. . . . .	176
Per cent load factor for English stations . . . . .	197
Per cent maximum demand factor for English stations . . . . .	196
Philadelphia load curve . . . . .	144
Relation between capacity and discharge rate . . . . .	231
Relation between capacity and specific gravity . . . . .	238
Specific resistance of acid . . . . .	115
Temperature variation during charge and discharge . . . . .	124, 125
Theoretical load curve . . . . .	143
Zurich load curve . . . . .	147
 <i>Installation illustrations:</i>	
Accumulator plant, Bowling Green, New York . . . . .	165
Accumulator plant, Brooklyn . . . . .	167
Accumulator plant, Philadelphia Edison . . . . .	170
Accumulator plant, Union Traction Co., Philadelphia . . . . .	175
Cell regulators, Philadelphia Edison . . . . .	172
Switchboard connections — Atlanta . . . . .	188
Switchboard connections — Bowling Green . . . . .	163
Switchboard connections — Burnley . . . . .	179
Switchboard connections — Chicago Board of Trade . . . . .	182
Switchboard connections — Zurichberg . . . . .	180
Switchboard connections — 12th Street, New York . . . . .	162
Switchboard, Philadelphia Edison . . . . .	171
 <i>Measurements — diagram of connections:</i>	
Internal resistance — Grassi . . . . .	248
Internal resistance — Mance . . . . .	248
Internal resistance — Sheldon . . . . .	247
E.M.F. — Negrenau . . . . .	249
E.M.F. — Cosgrove . . . . .	249

## ABBREVIATIONS

E. W. . . . .	Electrical World, New York.
N. Y. E. E. . . . .	Electrical Engineer, New York.
L. E. R. . . . .	Electrical Review, London.
L. E. . . . .	The Electrician, London.
El. Anz. . . . .	Elektrotechnischer Anzeiger.
Wied. Ann. . . . .	Wiedemann's Annalen.
Trans. A. I. E. E. . . . .	Transactions of the American Institute of Electrical Engineers.
A. P. . . . .	American Patent.
B. P. . . . .	British Patent.
F. P. . . . .	French Patent.
G. P. . . . .	German Patent.
L. . . . .	Lighting.
T. . . . .	Traction.
G. . . . .	Glass.
R. . . . .	Rubber.
W. . . . .	Lead-lined wood tank.
Cd. . . . .	Cadmium.
Alka—Zn . . . . .	Alkaline—Zincate type.
Pb—Zn . . . . .	Lead—Zinc type.
Pb—Cu . . . . .	Lead—Copper type.
Chlor . . . . .	Chloride battery.

# THE STORAGE BATTERY



## INTRODUCTION

ACCORDING to Houston, a storage battery, accumulator, or secondary battery, as it is variously called, "consists of two inert plates of metal, or metallic oxide, immersed in an electrolyte, which is incapable of acting upon them until a current has been passed from one plate to another. On the passage of a current through the electrolyte, its decomposition is effected, and the electro-positive or electro-negative radicals are deposited on the plates, so that on the cessation of the charging current, there remains a voltaic cell, capable of generating an electric current." A primary battery, on the other hand, is active in itself, and will give off electric manifestations without being acted upon by a current of electricity from some external source. There has been much controversy, of late, concerning the reason for calling the peroxide, the positive, rather than the negative plate, as is the custom with many English electricians. In answer to this, the *London Electrician* stated editorially that the "positive plate of a secondary battery is properly so called because it is plum-colored

and peroxidized, while the negative plate is of a neutral-color and not-oxidized."

As an economic factor in the working of stations for the production of electric light or power, the value of the storage battery is becoming more and more recognized. In a paper read before the American Institute of Electrical Engineers, Mr. C. L. Edgar<sup>1</sup> stated that the uses of accumulators for central station purposes, might be classed under four principal heads, viz. :

I. To carry "the peak of the load"; that excessive portion of the load, namely, which in electric lighting stations has to be carried, for two or three hours a day only.

II. To carry the entire load at minimum hours.

III. To act as equalizer or reservoir.

IV. For the equipment of annex or substations.

The peak of the load in the majority of stations represents from one-third to one-half the total maximum load of the station. While some engineers have advocated the use of cheaper and comparatively inefficient, though reliable apparatus for this purpose, the majority of managers are equipping their stations with accumulator plants.

Although accumulators are used in Europe for carrying the entire load at minimum hours, the consensus of opinion in America is that the nature of the load is against this practice, the period of minimum load being too short to warrant laying off a shift of men, or to show the economy of banking or drawing the fires.

<sup>1</sup> Trans. A. I. E. E., Vol. 12, p. 592.

Miller claims that when accumulators are used for equalizing the load, at least 15% per year is saved in fuel. By the use of accumulators in the station of the Boston Edison Illuminating Co., the load on the engines is never less than three-fourths of the maximum. In this case, the battery costing \$50,000 was used instead of a steam engine and dynamo, of the same capacity, costing \$65,000. One of the first railway plants to use storage batteries for equalizing the load, was the power station at Zurich, Switzerland. Results there have shown that a saving of 2.2 pounds of coal per horse-power-hour is effected, representing \$2500 per year. Allowing for interest and repairs of accumulators, which, with accompanying apparatus, cost about \$7400, the cost is saved in about four years by the saving in coal. Since, however, the adoption of the battery system replaced more expensive machinery, and therefore actually reduced the first cost, the saving is a direct one, and in a comparison should be credited with the interest charges on the reduction in first cost, and the maintenance of the machinery displaced.

Another growing use of secondary batteries, is for telegraph and telephone work, where it replaces the primary cells formerly in use. Of course, where the size of the installation warrants it, dynamos are used, but in the smaller offices, it has been found that the practically constant E.M.F. and internal resistance of storage batteries, the absence of "creeping" salts, corroding connections, etc., are strong arguments in favor of the use of secondary batteries. The Baltimore offices of the postal Telegraph Co., the Atlanta, Ga., and the

Washington, D.C., offices of the Western Union, the Central Railroad of New Jersey, Long Branch, Scranton, Pittsburg, and Hartford are among the most prominent recent storage battery installations. At Washington, 724 Chloride cells have replaced 7300 Gravity cells, and at Atlanta, 700 Chlorides have replaced nearly 8000 Gravity batteries. Storage batteries are also used by the Stock Quotation and Telegraph Co. for the operation of their instruments.

For traction purposes, the storage battery is still in the experimental stage, although used to a small extent in Europe, and on a few experimental roads in this country. Within the past few years, the storage battery has been used for self-propelled vehicles, and for this purpose has easily taken the lead among the prime movers. The earliest example, perhaps, was the "Electrobat" of Morris and Salom.

Hitherto, the capacity of the storage battery has been strained and its powers overestimated, but since the manufacturers have become more conservative in their claims, its applications have begun to extend. This, together with the great first cost, and the rapid deterioration of an accumulator, the latter being due, partly at least, to the efforts to secure lightness and to reduce the cost, will account for the fact of storage batteries having been so little used.

Although the practical history of the storage battery is included in the history of the past thirty years, the knowledge of the phenomena upon which its actions are based, dates back to 1801. In 1800, the year made memorable by Volta's discovery of the galvanic battery,

Nicholson and Carlisle found that a current from Volta's cell could decompose water. In 1801, Gautherot found that if the platinum or silver electrodes were connected together, after having a voltaic current passed through them, that a secondary current of short duration would flow. Erman found that the positive pole of such a cell, was the pole which had been connected to the positive pole of the battery. In 1803, Ritter observed with gold wire the same phenomenon as Gautherot, and constructed the first secondary battery, by superposing plates of gold, separated by cloth discs, moistened with ammonia.

Volta, Davy, Marianini, and others added somewhat to the knowledge on the subject, and in 1837, Schoenbein found that peroxide of lead could be used in secondary batteries. Sir William Grove next came forward with the discovery that metal plates, with a layer of oxide on them, acted better than the plain metallic plates, and Wheatstone and Siemens found still later that peroxide of lead was the best for such purposes.

In 1842, Grove constructed his famous gas battery, in which the E.M.F. came from the oxygen and hydrogen evolved in the electrolysis of water acidulated with sulphuric acid. By means of fifty such cells, he obtained an arc light. Michael Faraday, when electrolyzing a solution of lead acetate, found that peroxide was produced at the positive, and metallic lead at the negative pole, and in his "Experimental Researches," he comments on the high conductivity of lead peroxide, and its power of readily giving up its oxygen. Although he made no apparent use of this discovery, it may be

considered as the next important step in the development of the storage battery. According to Niblett, Wheatstone, de la Rue, and Niaudet were well aware that peroxide of lead was a powerful depolarizer, but nobody appears to have made use of this fact until 1860, when M. Gaston Planté constructed his well-known cell with coiled plates. M. Duerlir claims that Sinstedden used the secondary action of lead in sulphuric acid in 1854. Although it is well known that Sinstedden did notice the peroxidation of a lead plate in sulphuric acid, we have no further proof that he put it to any practical use.

Planté's researches extended up to 1879, and practically determined the state of the art. As to the theory at this time, it may be stated that Clerk Maxwell, although the leading electrician of his time, speaks of the storage battery as storing up a quantity of energy in a manner somewhat analogous to the ordinary condenser; hence the use of the word accumulator for storage battery. In 1879, R. L. Metzger did away with the tedious forming process, by mechanically applying the active material. This important discovery was not, however, generally known, until 1881, when Camille Faure obtained important patents concerning the method of shortening the time of formation. Charles F. Brush, working independently of either Faure or Metzger, arrived at the same result, and the United States Courts have decided, after long litigation, that to him belongs the priority of invention in this country.

It has been claimed by many that Planté, himself, was the true discoverer of the mechanical application of the



oxides. R. Jamins, in his work entitled "Recherches sur les Accumulateurs Electriques," says :

"Le grand inconvenient de la pile Planté reside . . . dans la longue durée exigée pour sa formation. M. Planté avait bien supposé qu'en déposant du minium sur les électrodes en plomb, il reduisait le temps de la formation de ses couples ; mais il ne parvint jamais a donner un adhérence suffisante au minium qui reculait et finissait par disparaître."

It should be noted, however, that Mr. Bedford Elwell, the translator of Planté's "Recherches sur l'Electricité," makes no mention of any process for mechanically applying oxides to storage battery elements, nor were the alleged troubles referred to in his translation.

Jablochkoff in an application for British patent 1745, April 22, 1881, states that M. Planté proposed to apply the active material mechanically to the support plate.

## CHAPTER I

### CLASSIFICATION OF BATTERIES

THERE are at present three classes of storage cells of commercial importance. The first, the Planté type, or autogenous cells, has plates composed of spongy or granular lead; the second, the Faure type, or heterogeneous cells, has lead plates, or, more commonly, plates composed of some alloy of lead, perforated with holes, or grooved, and filled with lead compounds; while the third, the alkaline type, comprise those cells using zinc in combination with lead peroxide or copper. There is also a fourth type, the gelatinous, or dry cells. These cells, though useful for portable work, and especially for traction and submarine purposes, have so many drawbacks, that they have not, as yet, found very much commercial application.

The preceding classification, although the most general, is not as good as Reynier's, by which the cells are divided according to their construction. This classification, which follows, will be used, with some modifications, in this work.

I. *The Lead-Sulphuric-acid genus.* — This class includes all those cells belonging to the Planté and Faure groups, thus including the great majority of the batteries in use to-day.

II. *The Lead-Copper genus.*—These cells consist of sheets of metal coated with lead oxide, serving as the positive electrode, and copper plates for the negative, immersed in a solution of copper sulphate. The batteries belonging to this class are not employed in commercial practice, being useful only for laboratory experiments.

III. *The Lead-Zinc genus.*—This group is very similar to the preceding, differing from it only by having zinc for the negative electrode, and zinc sulphate for the electrolyte. The E.M.F. of these cells is slightly higher than that of the ordinary cells, and their capacity per unit of total weight is very high; but they are apt to lose their charge on open circuit, besides possessing most of the disadvantages of the Planté cells.

IV. *The Alkaline-Zincate genus.*—In these batteries, copper is used as the positive, and iron plates, or, more commonly, iron gauze, as the negative electrode, and sodium, or potassium, zincate as the electrolyte. This type of cells has been used to some extent for traction purposes, with very fair results.

V. *Miscellaneous.*—All those cells which cannot be classed under any of the four preceding heads.

The first class, the lead-sulphuric-acid genus, is, as mentioned, divided into A, the Planté; and B, the Faure groups of accumulators. Each of these two groups is again divided, according to the improvements in each, as follows:

A. THE PLANTÉ. — The improvements are :

1. *Chemical, or Electro-chemical.* — The plates coming under this head are subjected to some sort of pickling process, or some special forming bath is used.

2. *Mechanical.* — These plates are made up of granulated lead wire, some form of finely divided lead, such as shot, molten lead mixed with some foreign substance before casting, or some special form of casting is used.

3. *Electrolytic.*

(1) The finely divided lead is obtained by the electrolysis of some salt of lead.

(2) Some salt of lead is formed into a plate by pressure, or otherwise, and then reduced to metallic lead.

4. *Plates built up of solid active material.* — While in reality being an improvement on the Planté type, these plates might be correctly classed as a third subdivision of the lead-sulphuric-acid group.

B. THE FAURE. — The objects in view in the development of this group are fourfold :

1. *The reduction of weight.*

(1) This is often accomplished by making the support plate of some alloy of lead.

(2) By making the support plate of some non-conducting substance, which is unaffected by acid.

2. *The retention of the paste, or active material.* — This is accomplished in four ways.

(1) The plates are grooved, have recesses on the surface, or are cast with small projections, so as to allow a lodgment for the active material.

(2) The support plate is perforated with holes, which are of three general types :

*a.* Those holes which have the same diameter throughout.

*b.* Those holes in which the diameter is smaller at the centre than at the surface.

*c.* Those holes in which the diameter is smaller at the surface than at the centre.

(3) The active material is enclosed by a perforated, conducting retaining case. Very often the plain or corrugated sheets of lead have been folded into boxes, either before or after applying the active material.

(4) The enclosing vessel is made of some non-conducting material, or some inert material is packed between the plates to prevent short-circuiting, and to retain the active material. In France the plates are covered with perforated sheets of celluloid.

3. *Provision for better contact between the support plate and the active material.*—This result is often accomplished by rubbing the support plate with carbon, before applying the active material. The addition of carbon to the paste is recommended.

4. *The prevention of buckling.*

E. J. Wade, in an article on the "Chemical Theory of Accumulators," claims that it will be difficult, if not impossible, for any metal to supersede lead for storage battery purposes, for the reason that the metals are dissolved by the electrolyte, while lead, because of its coating of sulphate, is insoluble. He says:<sup>1</sup>

<sup>1</sup> London Electrician, Vol. 33, p. 603.

“Herein lies the superiority of lead-lead-peroxide cells to all others. If properly treated, it may be regenerated electrolytically, and so nearly to its original chemical and physical condition, that it can be charged and recharged in this way hundreds and even thousands of times, before the total results of the slight changes that do take place, depreciate it sufficiently to incapacitate it for further use, while with all other cells, the changes that occur with each charging are relatively so large, that although all possible means have been tried to reduce them to a minimum, they rapidly deteriorate, and require constant attention and repairs. The reason for the more complete reversibility of a lead cell is entirely due to the chemical behavior of certain of the compounds into which the metal enters. Lead alone, of all the metals, forms a sulphate that is practically insoluble and unacted upon in water and dilute sulphuric acid, and it also combines with oxygen to form a peroxide, having a good electrical conductivity, and equally unaffected by the liquid. When, therefore, a lead-lead-peroxide couple is discharged in dilute sulphuric acid, the lead sulphate, which is the ultimate product formed at the poles, does not dissolve up in the solution, but remains on the surface of the plates ready for reduction and reoxidation when the current is reversed. Any local action that goes on when the cell is not at work, also results in this insoluble sulphate, which tends to form a protective coating on the metal, and thus reduces losses from this cause to a minimum. The compounds formed, when other metal than lead is used as the negative, not

necessarily in a sulphuric acid electrolyte, but in any other practically possible solution, are all soluble, and dissolve in the liquid as fast as they are formed, and this simple fact has, up to the present, barred the way to any substantial progress with these classes of reversible cells."

## CHAPTER II

### LEAD-SULPHURIC-ACID GENUS

#### I. — *A.* PLANTÉ TYPE

##### THE PLANTÉ CELL

IN 1860 M. Gaston Planté constructed the first practical secondary battery. He used two sheets of lead, 60 cms. long, 20 cms. wide, and 1 mm. thick, coiled about a wooden cylinder, insulated from each other by pieces of felt, and immersed in dilute sulphuric acid, — 1.070 specific gravity. On sending a current through the plates, the electrolyte was decomposed and hydrogen and oxygen thrown off. The hydrogen was given off at one pole, thus producing a very bright surface of pure lead. The oxygen, which was given off at the other, produced a plate of lead peroxide. After discharge, which continued until the plates had assumed their normal condition, the connections were changed, and the cell was recharged in the opposite direction. By several such reversals the capacity of the cell was found to be much increased.

It has been assumed by many writers that the Planté cell was one of inherently small capacity. That this is not true will be seen from the following figures. Planté found that the completed cell gave 7.25 ampere-hours



per pound of lead, a result which has not been exceeded in any cell of the same type upon the market to-day. This result was obtained with a charging current of 8 to 10 amperes per square metre of total surface of his plates,—counting the double surface of each plate. For the discharge Planté states in a letter to Dr. Leonard Paget, and from which the above results are taken :<sup>1</sup>

“For the discharge, I believe we may without inconvenience discharge with a notably stronger expenditure than 10 amperes, if the end pieces, or flattened parts of the plates, are sufficiently thick so as not to become heated, and consequently get brittle under the influence of the passage of the discharge current.”

Gerald has also found that such a cell has an energy efficiency of 72 %, with a capacity of 11,239 foot-pounds per pound of lead.

The chief drawback to this cell is that a number of reversals are necessary in order to obtain good storage capacity, and that when the maximum capacity has been reached the plates are about rotten. These reversals are troublesome as well as expensive.

In the later cells belonging to the Planté type, these reversals have been entirely done away with, and the formation is accomplished in a few hours by means of pickling or forming baths. All batteries of the Planté type, although they may be classified under the second, third, or fourth subdivisions, are now formed by means of these baths.

<sup>1</sup> Chips from a True Workshop, E. W., Vol. 26, p. 151.

## IMPROVEMENTS IN TYPE A

## I. Chemical or Electro-chemical

## PLANTÉ

In order to accelerate the formation of his plates, Planté<sup>1</sup> pickled them in nitric acid, diluted with one-half its volume of water, allowing the plates to remain in this bath for 24 to 48 hours. The couples were then washed thoroughly in a 10% sulphuric acid solution and formed; a certain quantity of the nitric acid was of course retained. According to Lucas the plates may be freed from the acid by washing them in ammonia, and then decomposing the resulting salt by heating to 200° C.

During formation heat is applied to the cell to open the pores and allow the electrolyte to penetrate more deeply into the lead; the plates are given a period of rest before each alternate charge. Planté found that by giving the plates this rest the oxide formed on the surface was bound more firmly to the plates, which would when thus treated lose the oxide by the evolution of gas on the true metal surface of the elements.

## THE ELWELL-PARKER ACCUMULATOR

In this cell<sup>2</sup> the positive plates are of the Planté type, and the negatives of the Faure. The positive plates are pickled in a bath of nitric and sulphuric acids for 30 hours. The negatives are of the ordinary grid type, somewhat similar to the Drake and Gorham (*vide*

<sup>1</sup> B. P., 3296; 1882.

<sup>2</sup> B. P., 3197; 1887.

page 70), the paste being applied under pressure and the edges blurred over, as in that plate. Wooden separators are used. These plates are used to a considerable extent in England, but the writer is informed that unless skilled attendants are in charge they give considerable trouble.

This company also manufactures a pure Planté cell, in which instead of coiled plates, cylindrical perforated lead sheets, weighing two pounds per square foot, are placed one within the other, with a clearance space of one-half inch. Before formation the plates are pickled for 24 hours in the regular bath. At least 30 reversals are necessary before they reach their full capacity.

#### EPSTEIN

Messrs. Woodhouse and Rawson, who manufacture this accumulator,<sup>1</sup> form their plates as follows: lead plates are placed in a 10% solution of nitric acid and water, which is maintained at a temperature of 100° C. for several days. When the coating is about one millimetre thick, the plates are dried in the air. The last traces of nitric acid are removed by placing the plates as cathodes in dilute sulphuric acid containing some copper sulphate, and passing a current until the plates are completely reduced to spongy lead. The plates are then formed in dilute sulphuric acid, containing pyro-tartaric acid. The grayish yellow color of the positive plates, which results from the acid treatment, is changed by the formation to a deep dark brown.

<sup>1</sup> A. P., 425,999; 1890. B. P., 6214; 1882: 4527; 1887: 350; 1890.

After being used, the peroxide plates become soft. In order to restore them to their former condition, it

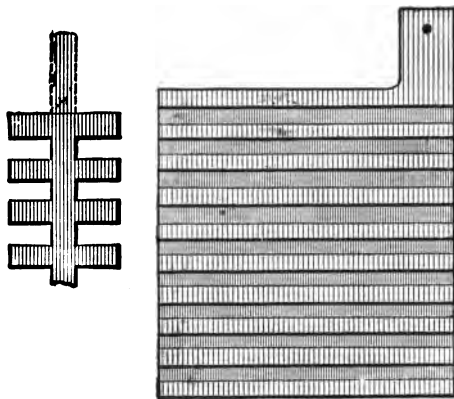

FIGS. 1 AND 2.

is best to reduce the peroxide with a negative, and then to reform with a positive current. The shape of the plates are shown in Figs. 1 and 2.

#### SCHOOP

The Schoop<sup>1</sup> plates, manufactured by the Oerlikon Co. of Switzerland, are placed in a solution containing 5 parts of sodium bisulphate, 0.75 parts potassium chlorate, and 95 parts of water, at a temperature of 25° C., and a current is passed; the current density used being about 0.33 amperes per square decimetre for 72 hours. The action is stopped when it has penetrated the plates to a distance of 2 mm. The coating is then reduced to spongy lead in dilute sulphuric acid

<sup>1</sup> A. P., 434,093; 1890. B. P., 7513; 1890.

(5%), with a current density of 1 ampere per square decimetre. The plates are thoroughly washed and are heated to nearly the melting-point of lead. Dr. Schoop<sup>1</sup> has also tried the method of making an amal-

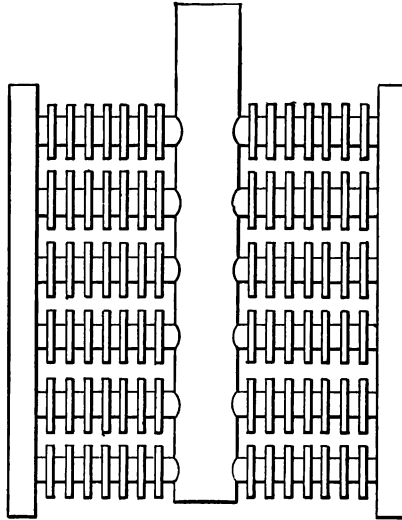

FIG. 3.

gam of lead and mercury, but does not think it to be practicable. Fig. 3 shows the form of the Schoop positive plate, the negative being similar in form, but without the centre rod.

## PAGET

Edward and Leonard Paget<sup>2</sup> in 1894 perfected a battery wherein the chemical method of formation is used. The lead plates are first boiled in dilute nitric acid to remove the "skin," after which a head-piece and tail-

<sup>1</sup> A. P., 434,301; 1890.

<sup>2</sup> A. P., 513,245; 1894. B. P., 17,223; 1888.

piece of type metal is cast on. The electrodes are then submitted to the action of a heated solution of nitrate of magnesium, after which they are assembled and formed in an electrolyte containing the double sulphate of magnesium and ammonium. They are then reassembled in a cell containing the proper electrolyte, and put into commercial use.

## WILLARD

The shape of this plate<sup>1</sup> is shown in Fig. 4. It consists of a sheet of pure rolled lead, deeply cut on

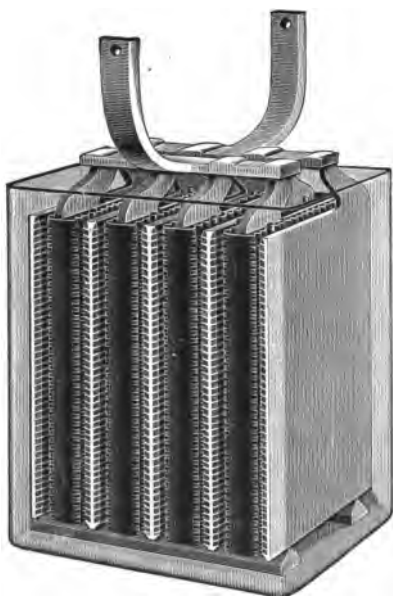

FIG. 4.

both sides, leaving leaves, or projecting shelves, at an angle to the surface of the plate, — the thickness and separation of the leaves depending upon the uses to which the battery will be put. The plates are then connected in groups of one hundred, and are placed in large tanks. These tanks contain a strong oxidizing solution, — the nature of which is a secret, — which

attacks the grooves or surfaces of the leaves, and, by

<sup>1</sup> A. P., 576,177-576,178; 1896: 532,128; 1895.

a continuous process, there is a thick adherent deposit of pure peroxide of lead produced which completely fills the grooves.

The plates are left in this solution for four hours, after which they are taken out, washed thoroughly, and assembled into elements, to receive their charge before shipping.

Each plate is protected by a corrugated hard rubber case, so highly perforated that there is perfectly free action for the electrolyte. That this is an economical

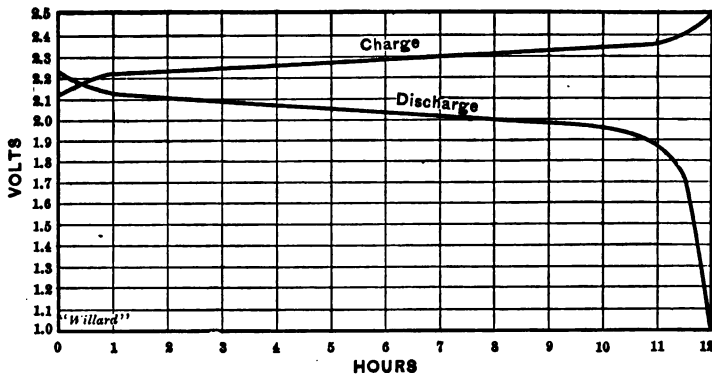

FIG. 5.

feature of the battery will be seen from the fact that all scalings are collected at the bottom of this cell, where they are held in contact with the central piece, thus continuing in service as active material. Buckling is impossible with this cell. A plate 7 × 8 inches has an active surface of 14 square feet. At no point is the active material more than  $\frac{1}{32}$  of an inch thick. These two points alone insure a very low internal resistance to the battery. The curve of discharge is shown in Fig. 5.

This company also manufactures a new type of cell—the concentric accumulator (shown in Fig. 6). The principal novelty in its construction is that it requires no containing cell, the negative element itself forming the containing cell. The method of forming is the same as with the other types.

#### THE ELECTRO-CHEMICAL STORAGE BATTERY CO.'S PLATE

This plate, shown in Figs. 7 and 8, was brought out by Madden and Chamberlain.<sup>1</sup> In the construction of the plate, a sheet of pure rolled lead is passed through a special machine producing deep grooves on either side of the plate; this process, termed spinning, produces 21 grooves to the inch. If desired, the plate may be cast instead of spun; in either case no rim is left on the plate. These plates are then placed in a strong oxidizing solution, which attacks the surfaces of the grooves, after which a current is passed, completely filling the grooves with pure peroxide of lead. This action, first chemical, then electrolytic, gives rise to the name "Electro-Chemical."

The active material being produced in this way possesses the highest conductivity, and precludes any local action between it and the grid. There being no frame exposed to the action of the electrolyte, local action is stopped, and the danger of short-circuiting reduced to a minimum. The manufacturers claim that this plate, possessing such a large effective area,—a plate measuring  $6 \times 7 \times 0.5$  inches, containing 700

<sup>1</sup> A. P., 572,363; 1896.



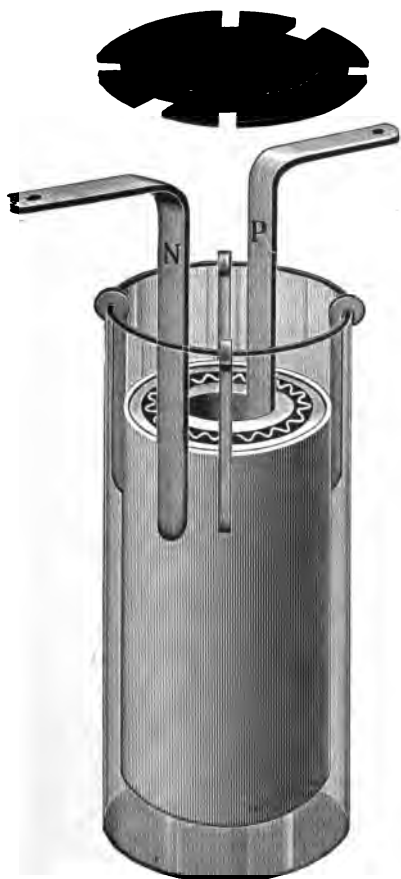

FIG. 6.



FIG. 7.



FIG. 8.

square inches, — reduces the percentage of expansion during both charge and discharge greatly, thus bringing to a minimum the chances of buckling and distort-

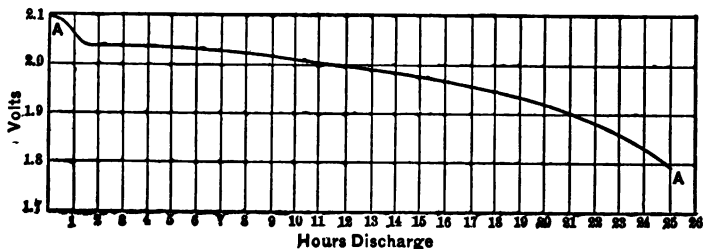

FIG. 9.

tion. Some very interesting curves for this battery are shown in Figs. 9 and 10. Curve *A* was taken from an S plate (cast), measuring  $6.625 \times 7.1875 \times 0.5$  inches, and weighing 5.5 pounds; *B* and *C* from an L plate (cast),  $8 \times 9 \times 0.5$  inches, weight 8.75 pounds; and *D*

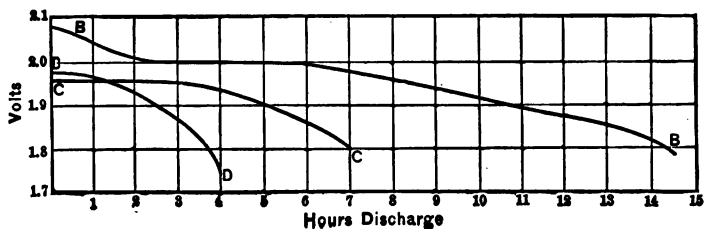

FIG. 10.

from an N plate (spun),  $6 \times 7 \times 0.4375$  inches, weight 4.5 pounds. In each case the discharge was at a constant current, 4 amperes for *A*, 7 amperes for *B*, 12 amperes for *C*, and 10 amperes for *D*.

## VARIOUS CHEMICAL METHODS OF FORMATION

Dujardin<sup>1</sup> uses as a forming bath a solution containing 10 kilos of water, 2 kilos of sulphuric acid, and 1 kilo. of alkaline nitrate, soda, potassium, or other suitable alkali. Boettcher uses a bath of sulphuric acid, acetic acid, and water. Garassino<sup>2</sup> places spiral perforated lead plates in a nitric acid bath for 12 hours, then in caustic potash, and finally in pure water, after which electrolytic spongy lead is formed in a hot caustic potash solution, and the plates are pressed. By mistake Starkey<sup>3</sup> placed some plates in dilute sulphuric acid, which contained a small quantity of a solution of chromic acid. He found that they set harder and quicker, and became more deeply peroxidized than in ordinary acid; they have since behaved in a most satisfactory manner. By cooking his plates in a solution of litharge in caustic potash or soda, Duncan produced a thick dense deposit of spongy lead.

It should be remembered that in order to have much success with electro-chemical methods of formation, only pure, soft, rolled lead should be used.

**2. Mechanical**

## DE MERITENS' CELL

Many of the early investigators with storage batteries worked along the lines of mechanical improvement in order to obtain the maximum amount of active surface

<sup>1</sup> F. P., 174,761; 1886. B. P., 16,408; 1886.

<sup>2</sup> B. P., 12,665; 1892.

<sup>3</sup> E. W., Vol. 27, p. 466.

for a given weight. Prominent among these stood M. de Meritens,<sup>1</sup> who constructed plates formed of thin lead laminæ 2 mm. thick. These lead laminæ were folded one upon the other somewhat in the form of a book, and the whole was soldered to a stout framework of lead. Having a large surface, a large amount of oxygen was required; the capacity, consequently, being increased, with the attendant disadvantage, however, of the local action being also increased. The film of peroxide was extremely thin.

Because of the rapid local action this accumulator was a failure, especially where required to maintain its charge for a lengthened period; but where a rapid rate of discharge was required, this type gave excellent satisfaction.

#### DE KABATH

This cell<sup>2</sup> is made in the form of a number of shallow perforated lead boxes, as shown in Figs. 11 and 12. Each box contains between

180 and 190 lead strips, alternately straight and corrugated. Lead strips, 50 cms. long, 1 cm. wide, and 1 mm. thick, are so corrugated that their

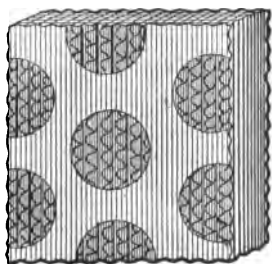

FIG. 11.

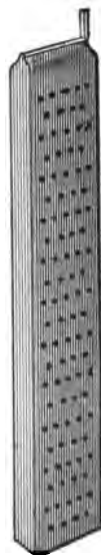

FIG. 12.

<sup>1</sup> B. P., 1173; 1882.

<sup>2</sup> A. P., 263, 124; 1882. B. P., 287; 1883. G. P., 21,689, 22,690; 1882.

length is reduced to 36 cms., the straight strips being of the same dimensions as the corrugated strips. The complete element measures 38 cms. in length, 9 cms. in width, and nearly 1 cm. in thickness, and weighs 2.2 pounds. The box may also be made of cardboard, caoutchouc, parchment, or other acid-proof material.

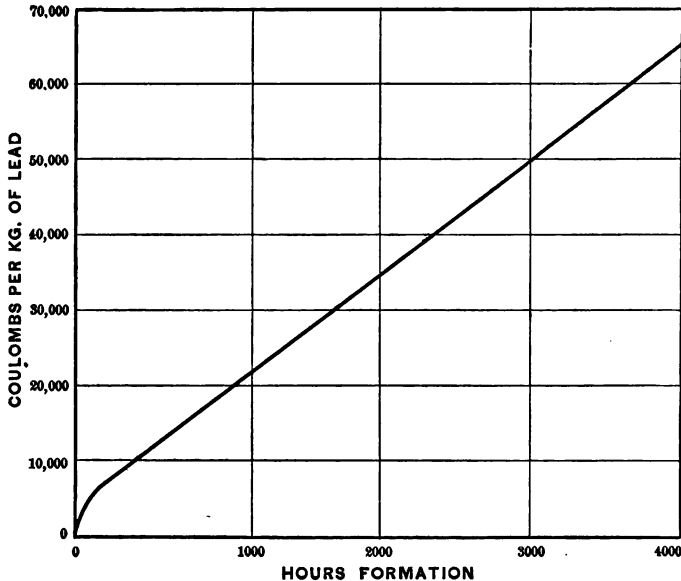

FIG. 13.

Fig. 13 shows the rate of increase of 1 kilo of lead when made up into this form of element at any period of time. This curve was obtained from a cell weighing 30 kilos, the weight of the elements being 21 kilos, and that of the electrolyte 6 kilos.

## REYNIER

Reynier sought to increase the exposed surface by making lead "plaits." His electrical connections being bad, he took a steel frame which had been dipped into an alloy of lead and antimony and placed the "plaits" in that. He found that when the plates were charged that they were less dense; they therefore buckled. To obviate this, longitudinal slits were cut in the plates, thus allowing for expansion.

## D'ARSONVAL

Hoping to obtain the largest surface for a given weight, d'Arsonval substituted lead shot for the solid lead plates. While this expedient would seem to give good results, it must be remembered that in order to be effective the shot must be in good electrical contact, but since they would soon become oxidized, it would be impossible to obtain good results.

## SIMMEN

Simmen substituted lead wire for the shot, with the result that his accumulator became much more efficient than that of d'Arsonval. The lead wire was obtained by pouring molten lead through a cullender into a pan of cold water. This sudden cooling makes the surface of the wire very rough, and the wire itself very light and porous, so as to be easily acted upon chemically. Masses of this wire were taken and pressed to the desired shape and placed in a perforated lead chamber, thus forming one electrode. Owing to the

chemical action on these leaden chambers the compressed wire was placed in a metal frame, which was but slightly acted upon by oxidation. This improved form has been termed the Simmen-Reynier cell.

## DRAKE AND GORHAM

These elements, usually known as the D. P. plate,<sup>1</sup> consist of a large number of narrow strips of lead, having points or projections on their faces; they are built up one above the other. A large working area is thus produced, and it is claimed that a cell of this type can be charged or discharged at a high rate without buckling or disintegration.

## GAUDINI

In this accumulator the plates are formed of a mixture of lead and coke and retort carbon. By the use of carbon the manufacturers claim to obtain greatly increased porosity, besides accelerating the formation. The electrodes are separated from each other by porous partitions. These partitions are made of any solid or gelatinous acid-proof material, and may be either straight or curved.

## PEYRUSSON

This accumulator<sup>2</sup> contains but two electrodes, placed one within the other. The positive element is in the form of a central rod, from which radiate thin sheets of lead, half a millimetre thick, and placed within a hollow cylinder, which forms the negative electrode. This cylinder is composed of sheets of lead, bent so as

<sup>1</sup> B. P., 10,608; 1892: 12,650; 1894.

<sup>2</sup> B. P., 8226; 1886. A. P., 523,371; 1894.

to expose both surfaces, and united by bands into the form of a cylinder.

#### THE STANDARD BATTERY PLATE

This plate, which has been brought out by J. H. Robertson,<sup>2</sup> is made by mixing pumicestone with lead while the latter is in a semi-molten condition. When thoroughly mixed, the mass is compressed to the desired shape and left to cool. This gives a very porous plate, having a large active surface. Owing to the nature of the pumicestone it is unnecessary to "eat it away." The makers claim that the heat of the molten lead renders the pumicestone more porous than it is ordinarily.

#### OHIO STORAGE BATTERY

In this battery a plate made from chemically pure rolled lead is passed through a machine which raises circular grooves, 1 inch in diameter,  $\frac{3}{16}$  inch deep, and  $\frac{1}{16}$  inch thick over the surface, each circle being independent, and separated from each other by  $\frac{1}{8}$  of an inch, as shown in Fig. 14. After the grooves are formed, the plate is put in a special solution, and the grooves are filled by electro-chemical action.

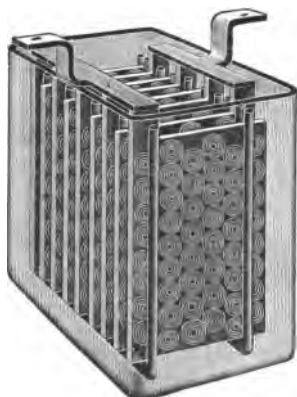

FIG. 14.

<sup>1</sup> A. P., 546,739 ; 1895.



For ordinary purposes the plates are separated by a hard rubber comb, but in cases where the cells will receive extra hard usage each positive plate is covered by a porous flexible envelope, thus absolutely preventing short circuits. It is evident that as one groove expands after usage it cannot crowd any others, except the ones in its own circle. All buckling is thus prevented.

#### NEW YORK ACCUMULATOR AND ELECTRIC CO.'S PLATE

This plate, which was brought out by Harris and Holland,<sup>1</sup> is shown in Figs. 15, 16, and 17. As will be

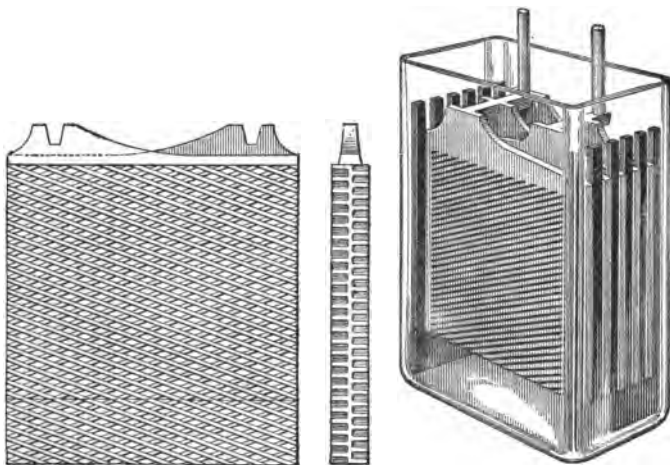

FIG. 15.

FIG. 16.

FIG. 17.

seen, it is an open-work, ribbed and grooved plate, with the ribs of one side crossing those of the other, and bodily, and therefore electrically joined to them. The

<sup>1</sup> A. P., 574,417; 1896.

plate is made either by casting in a mould, or else by pressing, rolling, or sawing it out of a piece of pure rolled sheet lead. The grooves are made at an angle of  $20^\circ$  to the horizontal. Where strength and durability are first considerations the plates are made heavier, every tenth rib being made thicker and the adjoining grooves wider. For some uses, the positive plates are protected by perforated sheets of insulating material secured to the plate by rubber bands.

These plates are formed by immersing them in a bath consisting of a mixture of dilute sulphuric acid (practically a non-solvent of lead) and nitric or acetic acids (both solvents of lead), which produces a coating of lead sulphate. They are then removed and subjected to the action of an electric current in an electrolyte consisting, preferably, of a moderately strong solution of magnesium sulphate, or its equivalent (as aluminum sulphate), and proportionately small quantities of sulphuric and acetic acids, and magnesium acetate, or equivalents therefor. Thus two actions are constantly taking place: the formation of lead sulphate by chemical action and the peroxidation of this sulphate by the current, the magnesium sulphate and acetate being used to facilitate the peroxidation of the difficultly peroxidizable lead sulphate. When the formation has penetrated to a sufficient depth, the plates are thoroughly washed, and subjected to the action of the current in an electrolyte of dilute sulphuric acid, and a proportionately small quantity of an acid sulphate, as that of sodium or potassium. This treatment completes the formation by converting any remaining por-

tions of the lead sulphate to peroxide, but does not increase the depth of formation. When fully formed, such of the plates as are intended for negatives, are reduced by connecting them to the negative terminal of the charging current. The electrodes are then ready to be assembled to form cells, where they are charged in the usual way.

By this process well-formed plates are obtained from the raw material in from 30 to 50 hours, depending on the strength of current. It is not advisable, however, to use too strong a current in forming.

#### THE AMERICAN BATTERY CO.

This plate is made from a solid sheet of pure rolled lead,  $\frac{1}{2}$  of an inch thick, and grooved on both sides, as shown in Figs. 18 to 20. These grooves are  $\frac{1}{16}$  of an inch wide and  $\frac{1}{16}$  of an inch

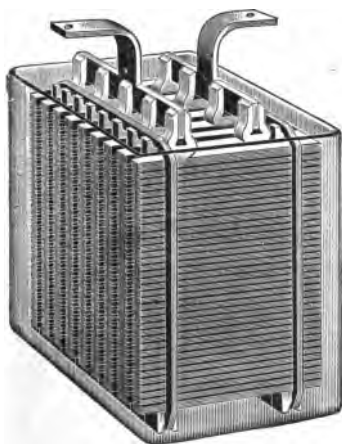

FIG. 18.

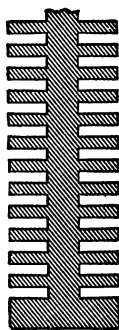

FIG. 19.



FIG. 20.

thick. The active material, formed electrically in a strongly oxidizing solution, completely fills the grooves.

For long life, in constant and severe service, this construction will be found to give excellent satisfaction.

In a former plate, brought out by Morrison,<sup>1</sup> lead ribbon was folded loosely upon itself, forming a square plate; the lead ribbon,  $\frac{1}{2}$  of an inch wide, was grooved on both sides. The strips were solidly united at the ends by a process which left the edges of the plate a solid bar of metal, practically acid proof; foot and terminal pieces of the same metal were also cast on. The grooves served, not only to key in the active material when formed, but also as canals, permitting the electrolyte to act freely on every part. The lead strips were so folded that they were about  $\frac{1}{10}$  of an inch apart; this allowed expansion to take place freely in a vertical direction. Rubber combs were used as separators.

#### ROONEY

For his central station, or high discharge type, Mr. Rooney builds his plates as in Fig. 21, which, as will be seen, is very similar to the De Kabath plate. Corrugated strips of lead ribbon, alternated with straight strips, are burned at one end. A number of these are then burned to a lead conductor, and the whole is electrically and mechanically connected to a lead

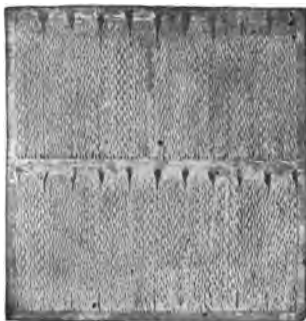

FIG. 21.

<sup>1</sup> A. P., 512,514-522,479; 1894.

frame. In this way all expansion and contraction are provided for, and buckling is unknown. As a further protection, the positive plates are surrounded by a perforated hard rubber retaining case. The plates are formed in a few hours by a nitrate solution.

#### VARIOUS MECHANICAL METHODS

Lane-Fox<sup>1</sup> makes his plate by alternating lead laminæ with sand. Pumpelly-Sorley<sup>2</sup> constructed theirs by clamping a sheet of pure rolled lead between two

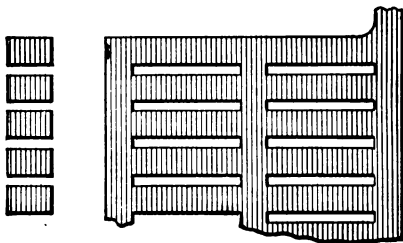

FIG. 22.

plate forms, and then bringing it against a gang of saws, thus producing the plate shown in Fig. 22. The manufacturers claim to have produced the first integral slotted rolled lead plate.

### 3. Electrolytic

#### (1) *Electrolysis of a Lead Salt*

##### MONTAUD'S ELEMENTS

This investigator coated a lead sheet with electrolytic lead, from a solution of lead in potassium and water.

<sup>1</sup> A. P., 285,807; 1883.

<sup>2</sup> A. P., 521,897-467,522; 1894.

The bath was heated to  $100^{\circ}$  C., so that the current density might be high. With a current of 600 amperes,

only 30 minutes was required for making the plates. After washing, the plates were ready to be formed. The shape of the plates is shown in Fig. 23, a rod of white metal connecting the plates of like polarity.

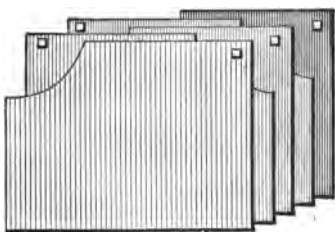

FIG. 23.

For this cell, the best charging rate is about 10 amperes per square metre of active surface, and the discharging rate about 20 amperes per square metre.

#### SILVEY

Silvey<sup>1</sup> places lead plates in a solution containing a mixture of acetic acid and potassium, and passes a current through the cell. This decomposes the anodes, depositing them in a metallic state on the cathodes. The cathodes are then removed, and the deposit is compacted by pressure; after which the plates are placed as positives in a storage cell and formed.

#### VARIOUS METHODS

Shultz<sup>2</sup> covers the lead with sulphur, and then heats it to form lead sulphide, after which the plates are placed in a bath and made spongy by electrolysis. Remington<sup>3</sup> immerses lead plates in a saturated solu-

<sup>1</sup> A. P., 512,757-523,689; 1894.

<sup>2</sup> G. P., 21,454.

<sup>3</sup> A. P., 342,855; 1886.

tion of lead in caustic alkali, and then deposits a coating thereon by electrolysis. Duncan<sup>1</sup> produces a coating by making the plates the anodes in a bath containing a solution of oxide of lead in potassium.

(2) *Eating away of Lead Salts*

WOODWARD

Woodward<sup>2</sup> pours molten lead on common salt, and while still pasty, the salt and the lead are thoroughly intermixed, and the plastic material is compressed to the requisite shape. The salt is then dissolved out and the plates are formed. In another type of battery, designed especially for traction purposes, the plates are placed horizontally, and sheets of porous earthenware, or other suitable porous insulating material, are placed between them.

CURRIE

In the manufacture of this grid,<sup>3</sup> a brass rod is placed in an asbestos tube. Fused lead chloride is poured into the mould, around the rod, and into the meshes of the tube, thus filling up the interstices of the asbestos, and forming a thin-walled tube. The brass rod is then withdrawn, and an alloy of lead and antimony is poured into its place, a connecting rod of the metal being cast at the same time. The chloride is then reduced by electrolysis, after which the plate is ready to be fitted

<sup>1</sup> B. P., 15,433; 1888.

<sup>2</sup> A. P., 392,373-392,374-393,954-393,955; 1888: 406,969; 1889.

<sup>3</sup> A. P., 447,279-450,834-453,995-459,491; 1891.

up and formed. Fig. 24 shows the arrangement of the plate. The elements can be used with positives of similar shape, or with flat positives of the ordinary style.

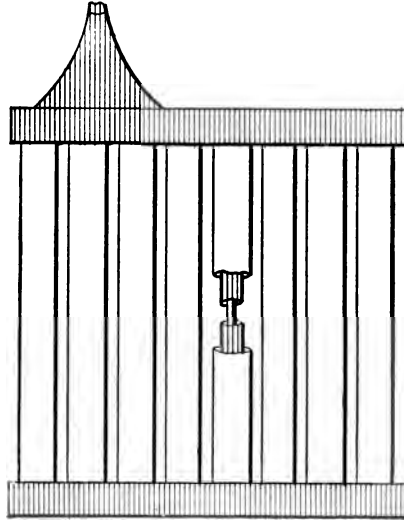

FIG. 24.

#### THE PAYEN ACCUMULATOR

There has been much controversy, of late, as to the originator of chloride plates. It has been settled by giving to Marchenay<sup>1</sup> the honor of first mentioning lead chloride for accumulator plates; to Maxwell-Lyte,<sup>2</sup> the honor of constructing the first chloride of lead plate; and to Andreoli,<sup>3</sup> that of introducing the first chloride of lead grid plate. It is to the Maxwell-Lyte type that the Payen<sup>4</sup> battery belongs.

<sup>1</sup> L. E. R., May 25, 1894. <sup>2</sup> A. P., 422,308; 1890. B. P., 3452; 1883.

<sup>3</sup> B. P., 8842-12,595; 1886: 18,807; 1892.

<sup>4</sup> A. P., 440,267-440,277-440,575; 1890.



In the manufacture of these plates, an intimate mixture of asbestos fibre and fused lead chloride is formed, and the molten mass poured into a mould, crystallizing as it cools. The result is a chloride of lead plate, bound together with asbestos fibre. By making this the cathode to an ordinary lead anode, the lead chloride is transformed into spongy lead, after which the plates are ready to be formed in the ordinary manner. A mixture consisting of 90-95% lead chloride, and 10-5% zinc or cadmium chloride is employed in the manufacture of the plates.

#### THE CHLORIDE STORAGE BATTERY

This battery, which is manufactured by the Electric Storage Battery Co.<sup>1</sup> of Philadelphia, has come into prominent notice of late years, and stands among the best of the batteries which are upon the market.

In the manufacture of this cell, commercial lead is reduced to a fine powder, dissolved in nitric acid, and then precipitated by hydrochloric acid. The lead chloride thus obtained is washed and fused with zinc chloride. The molten metal is poured into a mould, and allowed to cool, forming pastelles, about  $\frac{5}{16}$  of an inch thick. For the positive plates, the pastelles are circular in form,  $\frac{3}{4}$  of an inch in diameter, with a bevelled V-shaped periphery; for the negatives, they are square,  $\frac{3}{4}$  of an inch on an edge. These pastelles are placed in a mould, and a lead-antimony grid is cast around them under pressure. By packing these grids

<sup>1</sup> A. P., 415,329-415,330-415,331-415,333; 1889: 477,182; 1892. B. P., 1229; 1893: 10,836-12,953-12,954; 1895. G. P., 57,053; 1890.

between zinc plates in a tank containing a dilute solution of zinc chloride, and short-circuiting them, most of the chlorine is extracted. The last traces of chlorine

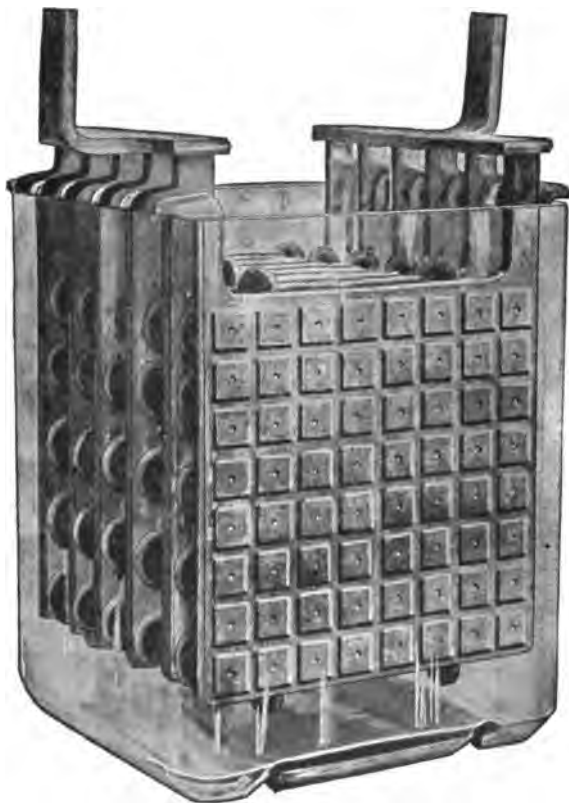

FIG. 25.

can now be removed by thoroughly washing the plates in running water; a pure spongy lead plate results. The positive plates are then formed by packing them tightly between perforated ebonite boards, in dilute sul-

phuric acid, and passing a current through them in one direction for two weeks.

Lately, however, the Electric Storage Battery Co. has abandoned this method of making positive plates, and constructs them of a lead-antimony grid  $\frac{5}{16}$  of an inch thick, and having circular holes  $\frac{3}{4}$  of an inch in



FIG. 26.

diameter; the grid being cast under pressure to make it dense. A corrugated, soft lead ribbon, also  $\frac{5}{16}$  of an inch wide, is bent into the form of a spiral, and is pushed into these holes; the active material being formed from this ribbon by electro-chemical process. The expansion of the active material, during use, tends to wedge the spiral more tightly within the hole, thus

improving the contact. This plate, known as the "Manchester" plate, was brought out by Rhodin.<sup>1</sup> It

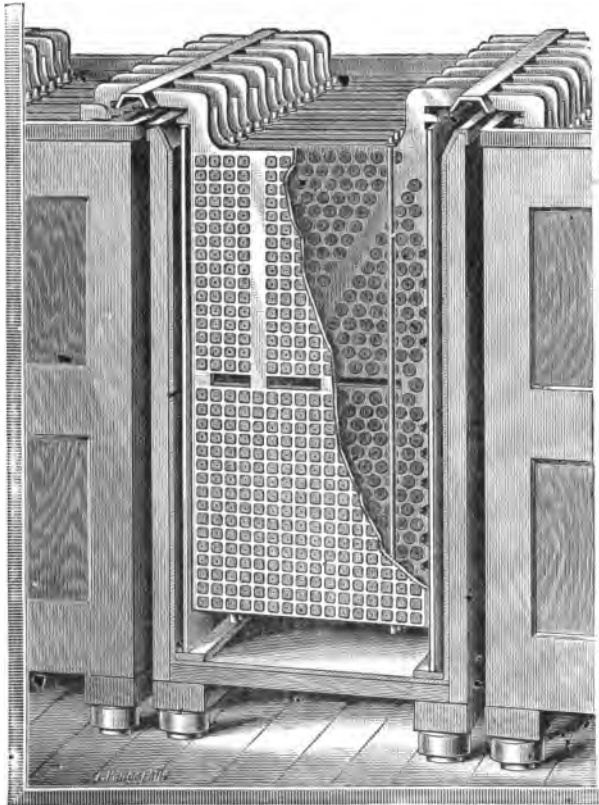

FIG. 27.

is constructed essentially like the original Brush plate, though the "active material," or material to become

<sup>1</sup> A. P., 567,044-567,045; 1896.

active," is a spiral of ribbon lead, instead of the paste or cement used by Brush.

In Figs. 25, 26, and 27 are shown the E-11 Portable cell, the ordinary Portable cell, and the Central Station

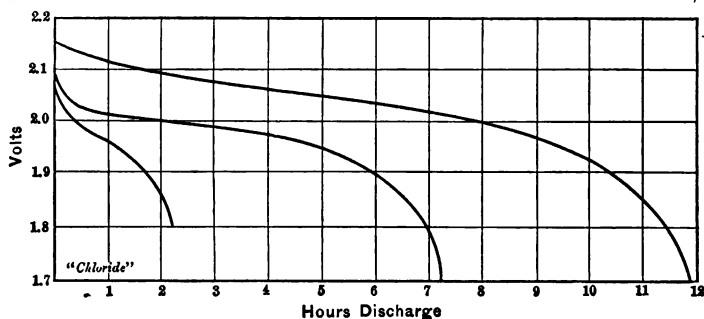

FIG. 28.

cell. Fig. 28 shows the charge and discharge curves of this battery. They were taken from a 75 A. H. cell, which was charged with a constant current, and discharged through a constant resistance.

#### VARIOUS METHODS OF FORMATION

Monnier<sup>1</sup> makes an alloy of lead with about 4% of zinc; the alloy is then cast into the desired shape, and the zinc eaten away. Tribe<sup>2</sup> used various salts of lead, mostly, however, the arsenides, phosphides, or sulphides; the salt was then reduced to spongy lead by electrolysis. Messrs. Beaumont and Biggs,<sup>3</sup> Fitzgerald,<sup>4</sup> and Crompton<sup>5</sup> used alloys of lead containing

<sup>1</sup> B. P., 1556; 1883.    <sup>2</sup> B. P., 2073; 1884.    <sup>3</sup> B. P., 12,818; 1886.

<sup>4</sup> B. P., 29; 1882. A. P., 524,710; 1894.    <sup>5</sup> G. P., 22,816; 1882.

tin, iron, or antimony from which the foreign material was eaten away by electrolysis. Pollak,<sup>1</sup> with some of his plates, uses lead carbonate and caustic potash mixed to a thick paste. They are then moulded to the required form and dried, after which a current is passed to reduce them to spongy lead.

#### 4. Plates of Solid Active Material

##### PERCIVAL'S SECONDARY PILE

In April, 1866, George G. Percival took out American Patent 53,668, for a secondary electric pile; this was

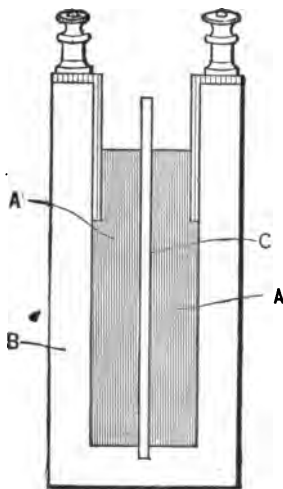

FIG. 29.

the first United States patent granted for storage batteries. It is constructed of solid active material, and is shown in Fig. 29. In this figure, *B* is a wooden containing box, and *C* is a porous partition. *A, A*, are layers of powdered gas carbon, powdered lead, or other suitable conducting powder. These two layers constitute the two electrodes, and when in use, are wet with dilute sulphuric acid. By placing these layers in a horizontal position, a layer of non-conducting

powder may be substituted for the partition.

<sup>1</sup> B. P., 813; 1893.

## FITZGERALD'S LITHANODE

Professor D. G. Fitzgerald<sup>1</sup> makes his "compressed active material" plate, by thoroughly mixing litharge and ammonium sulphate, and then allowing the mass to dry slowly under pressure, in the requisite shape. The plate is converted into peroxide, by placing it in a bath of magnesium hypochlorite, or other suitable chlorine compound, for a preliminary coating; this insures uniform peroxidation in the forming. The forming is effected electrolytically in a bath of sulphate of magnesium, for a lengthened period. The preliminary coating, may, however, if desired, be applied mechanically. The contacts are of some unoxidizable metal, such as gold or platinum. The plate is used as a positive to a negative of ordinary lead. By the use of lithanode, a positive plate is obtained which is unusually free from local action, and the manufacturers claim that fully 90% of the positive plate is lead peroxide.

In discharging a battery containing lithanode plates, care must be taken not to run the E.M.F. down below 1.8 volts per cell. Professor Fitzgerald claims that when used according to directions, the electrical capacity of lithanode is almost exactly one ampere-hour per ounce; the best rate of discharge being  $\frac{1}{4}$  of an ampere per square inch of lithanode plate.

## McLAUGHLIN

The electrode for this battery<sup>2</sup> consists of a conducting core having a ledge or seat at its lower extremity,

<sup>1</sup> A. P., 524,710; 1894. B. P., 3731; 1890.

<sup>2</sup> A. P., 424,809; 427,785; 432,202; 1890: 475,335; 1891.

on which is placed a block of active material, so that the entire surface of the active material, except the lowest side, is exposed to the electrolyte. The makers claim for this type of battery that there will be no twisting, warping, or buckling, and that the battery will stand a high rate of discharge.

#### BOESE

The Boese<sup>1</sup> plates consist of a solid slab of active material, enclosed in a lead frame, similar to the frame of a slate. The slabs are formed of minium for the positive, and minium and litharge for the negative, these being formed into a paste with alcohol, containing certain hydrocarbons, such as anthracene, obtained from a distillation of coal tar. After being moulded and pressed into the frame, the plates are pierced with a large number of small holes, for the escape of the gas; they are then baked, and placed in a dilute sulphuric acid solution to harden, after which they are formed. These plates are said to be extremely porous, and to have a conductivity nearly equal to that of lead.

More than 20,000 of these cells are in use on the German and Hungarian postal railway cars for lighting, where they give excellent satisfaction.

#### VERDIER

Verdier<sup>2</sup> mixes a lead oxide with a vegetable oil, or a mixture of glycerine and water, to a thin paste. The material is dried in air, and perforated. The plates are

<sup>1</sup> G. P., 78,865; 1892.

<sup>2</sup> B. P., 8973; 1889.



then transformed to spongy plates by treatment in a solution of sodium sulphate, and a mixture of glycerine and water ; after which they are formed in dilute sulphuric acid.

## DESRUELLES

Desruelles<sup>1</sup> mixes 60 parts of lead peroxide, 40 parts of graphite, 25 parts of pulverized porcelain, and 10 parts of white of egg, presses into shape, dries, and heats until the albumen coagulates. A very porous and extremely hard plate results.

<sup>1</sup> G. P., 61,620 ; 1891. B. P., 4877 ; 1891.

## CHAPTER III

### LEAD-SULPHURIC-ACID GENUS

#### I. — *B.* FAURE TYPE

THE formation of accumulators by means of reversals being an expensive as well as a troublesome process, Metzger and Faure maintained that, if the active material were mechanically applied, the previous tedious formation would be saved, and that better results would be obtained than with the old process. Experience has proved the wisdom of these views, and to-day the use of these two types is evenly divided, European practice favoring the Faure type, and American practice the Planté type. The advocates of the pasted type claim that a larger percentage of the total weight of the plate consists of active material, and that this, while not conducive to high rates of discharge, permits the Faure cell to take in a greater charge, and to obtain a greater staying power than is possible with the Planté cell. On the other hand, the Planté cell will do what the Faure, with equal weight or surface, will not do, — produce rapid discharges in currents of great volume.

#### METZGER

In 1878, R. L. Metzger,<sup>1</sup> of Alt-Breisach, Germany, took a sheet of perforated lead, 1.5 mm. thick, formed

<sup>1</sup> El. Anz., 1892; 651.

it into the shape of a box, about 7 mm. deep, and filled it with a paste composed of a lead oxide, dilute sulphuric acid, and potassium silicate. After the paste was thoroughly dry, a perforated lead cover was soldered to the box. Two such elements, placed in dilute sulphuric acid, composed the battery. From 48 to 72 hours was required for the formation.

Somewhat previously to this Metzger had used the two paste-filled boxes in the form of a hollow cylinder, placed the one within the other. The lower part of each was filled with some insulating material. This, not proving satisfactory, was abandoned for the flat electrode type.

#### FAURE

Although used in 1878 for the first time, the pasted type was not universally known until 1880, when Camille A. Faure,<sup>1</sup> working independently of Metzger, took out patents on that type. He took a lead oxide, in the form of a paste, spread it upon a spiral Planté plate, and allowed it to dry. It was insulated from the negative element by means of felt, or parchment paper, and the whole was replaced in dilute sulphuric acid. According to some tests by Lord Kelvin, this type gave about 12,000 foot-pounds per pound of cell complete. In a cell composed of 16 plates, each 17 × 12.5 inches, the amount of lead oxides present was 50 pounds, and the total weight of the cell, 135 pounds. The capacity

<sup>1</sup> A. P., 252,002; 1882: 309,939; 1884. B. P., 129: 1676; 1881: 1769; 1882. G. P., 19,026; 1881.

was 176 ampere-hours, at an 8-hour rate, and 299 ampere-hours at a 14-hour rate. The great disadvantage with this cell is that "lead-trees" are soon formed.

### IMPROVEMENTS IN THE FAURE TYPE

#### 1. Reduction of Weight

##### (1) *Use of Alloys*

##### HAGEN

In this battery, brought out by Gottfried Hagen,<sup>1</sup> of Germany, the lead frame consists of two halves, each composed of ribs crossing each other at right angles. Each rib is in the form of a triangular prism, with its base outwards. The two halves are not cast solid along the inner edge of the ribs, but are some distance apart, and are held together by a series of short cross-bars, the entire frame being cast in one piece. In this way a very light and yet strong frame is secured, and one which is capable of holding firmly a large amount of active material. The plates are kept apart in the cell by means of corrugated, perforated celluloid separators, which offer considerable resistance to lateral pressure. For stationary batteries the ratio of the weight of the active material to the total weight of the plate is 50%, while for transportable batteries it is 60%. The discharge should never be continued under 1.88 volts.

##### JAMES

In this accumulator the positive plate consists of an alloy of lead with 1% of cadmium, the negative

<sup>1</sup> G. P., 52,880; 1889.

containing 2% of antimony. Both plates are pierced with circular holes, in which the active material is placed.

For the positive plate the active material consists of the following mixture: minium, 85%; litharge, 10%; carded asbestos, 4%; and powdered carbon, 1%. That for the negative contains: litharge, 94%; asbestos, 4%; sulphur, 1%; and powdered carbon, 1%.

#### KNOWLES

The grid for this battery<sup>1</sup> is composed of an alloy of 82% of lead, 16% of tin, 1.9% of antimony, and 0.1% of arsenic. Solid blocks of active material composed of 75% of red oxide of lead (minium), and 25% of yellow oxide of lead (massicot), first thoroughly mixed, and then treated with sulphuric acid, and hardened, are placed between these perforated grids, which are held together by rivets. The makers claim that by this means a very light, as well as an unoxidizable, grid is obtained.

#### VARIOUS METHODS

In the Jacquet<sup>2</sup> battery the grid is composed of a white metal alloy. Worms uses 96.5% of lead, 2.2% of antimony, and 1.3% of mercury for his grid. Julien employs 92% of lead, 4.5% of mercury, and 3.5% of antimony. Nevins uses 30 parts of lead, and 100 parts of tin. The usual alloy used is 96% of lead to 4% of antimony.

<sup>1</sup> A. P., 480,266-482,979-483,562-483,563; 1892: 538,919; 1895.

<sup>2</sup> B. P., 18,028; 1889.

*(2) Use of a Non-conducting Support*

## HATCH

In the old form of Hatch<sup>1</sup> battery the lead salts were contained within the corrugations, or grooves, of a highly porous zigzag plate of earthenware. When these grooves were so filled as to present an even surface, the requisite number of packed plates for a complete cell were bound together between stout wooden boards by means of flexible rubber bands, each plate being separated from its neighbor by a sheet of two-pound lead, which served as a conductor. Its internal resistance varied from 0.01 to 0.042 ohm. Each packed plate was capable of absorbing 50% of its weight of water. 54% of the total weight of the plates was active material.

In the latest type of plate<sup>2</sup> porous unglazed earthenware is used, having square receptacles on its face side, and grooves on its reverse side, as shown in Figs. 30 to 33. The face of each plate is packed with red lead, filling the small squares, and rising  $\frac{1}{8}$  of an inch above the surface of the plate, so as to secure an agglomeration with the electrode during the forming process. The packed plates are then placed back to back, with the grooves crossed, as shown in the figure. As in the older type, two-pound sheet lead is used for the electrodes, and is placed between the packed surfaces of two adjacent plates. Fig. 33 shows a completed accumulator, bound by means of stout rubber bands between

<sup>1</sup> A. P., 441,413; 1890.<sup>2</sup> A. P., 585,472-585,473; 1897.

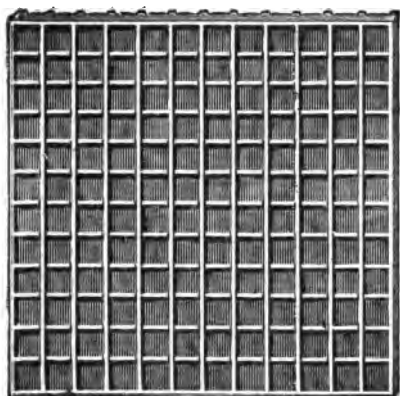

FIG. 30.

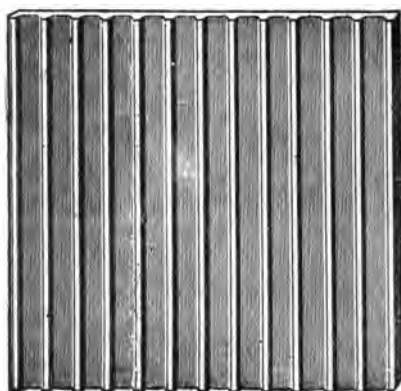

FIG. 31.

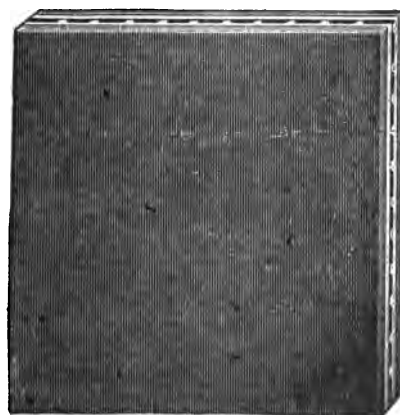

FIG. 32.



FIG. 33.

rigid backs. By this means a circulation of the electrolyte is obtained, and an escape for the gases formed is provided. The elasticity of the element allows for the expansion and contraction of the active material, without closing the pores of its own mass. The manufacturers claim that as no amount of current in either direction can possibly injure the element, it is admirably adapted for central station purposes, and that the abso-

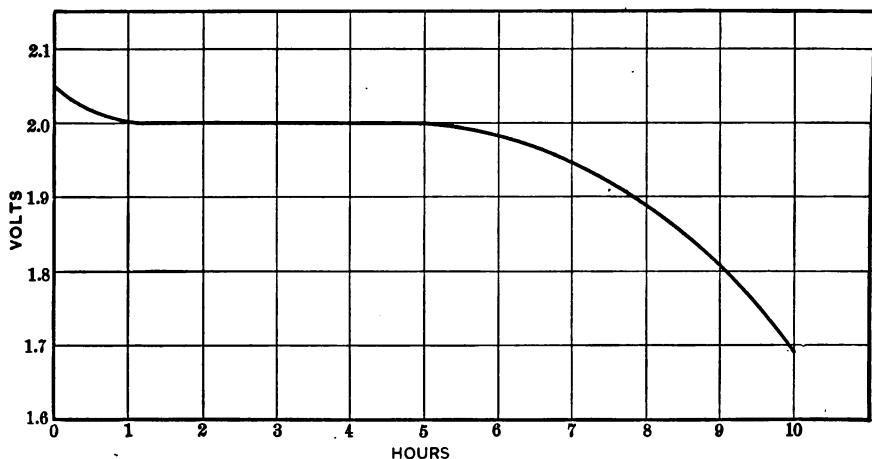

FIG. 34.

lute confinement of the active material avoids deterioration by loss of that important part of the battery. The internal resistance of the cell, at a 10-hour rate, is 0.006 ohm. Taking account of the weight of the central conductor, it has been found that 65%, or, omitting this factor, 77%, of the weight of the plates is active material. The earthenware plates used will absorb 40% of their weight of water. In Fig. 34 is shown the discharge



curve of a 100 ampere-hour cell, discharged at a constant current of 10 amperes.

## WINKLER

An element of the Winkler<sup>1</sup> battery consists of a series of troughs, of an acid-proof non-conducting material, such as celluloid or vulcanite, in a frame of the same material. The element is dipped in the active material, which is in a semi-liquid condition; any excess of the active material being brushed off after drying. A lead conducting wire is placed in the bottom of the trough, and is embedded in the active material. The electrolyte is a gelatinous mixture of sodium silicate, sulphuric acid, and ammonium sulphate. The forming charge lasts 26 hours. Where lightness is not a prime desideratum, the element is made of lead, and the electrolyte dilute sulphuric acid.

## VAN EMON

In this electrode,<sup>2</sup> a non-porous, non-conducting grid is perforated, usually with square holes. Perforated plates of lead are placed on one side of the electrode, the other side being open to the electrolyte. Ribbed separating frames are placed between the positive and negative plates.

## ROONEY

In this plate,<sup>3</sup> a cut of which is shown in Figs. 35 and 36, the grid is built up of layers, or strips, of wool-felt, which are placed in parallel rows at right angles

<sup>1</sup> A. P., 471,590-471,591-471,592; 1892.    <sup>2</sup> A. P., 524,656; 1894.

<sup>3</sup> A. P., 549,023-549,077; 1895; 574,826; 1896.

to each other, thus leaving square holes, or pockets, for the reception of the active material. In order to make metallic contact with the paste, perforated lead conducting strips are placed midway between the faces of the plate.

In the construction of the plate, sheets of wool-felt, painted on one side with a cement, which has been softened by heat, are cut into narrow strips, about  $\frac{1}{8}$  of an inch wide, and of the required length, these strips



FIG. 35.



FIG. 36.

being laid in parallel rows in a form. When the grid has reached half its thickness, the lead strips are laid in place, and when the form has been filled, heat is applied to soften the cement. The plates are cooled slowly under heavy pressure, which is maintained until the cement has hardened, after which the grids are lifted from the form.

The grids are then pasted as though metallic, and when set, the lead strips are firmly embedded in the

active material, leaving no metallic surface exposed to the action of the electrolyte. Lead connectors are burned to the centre conducting strips, and the whole plate is surrounded by a perforated non-conducting retaining case.

During expansion the paste presses more firmly into the felt, thus absolutely preventing all buckling.

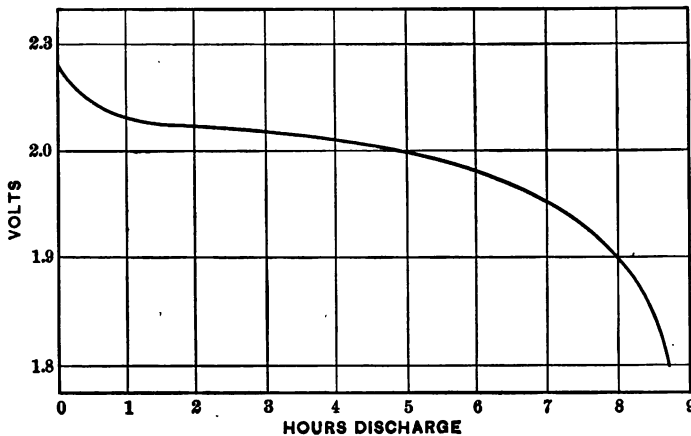

FIG. 37.

This grid will absorb 230% of its own weight of water.

Mr. Rooney has thus succeeded in obtaining a very light yet strong plate, and one which has been found to give excellent satisfaction under the most severe conditions. Fig. 37 shows a curve taken from a 5-plate cell, charged at a constant current of 7.8 amperes, and discharged through a constant resistance, the average current being 8.92 amperes.

## THE UNION STORAGE BATTERY

In this battery,<sup>1</sup> which was put upon the market in 1898, the plates consist of horizontal porous earthenware concave dishes, or saucers, filled with the active material, the active material being placed in the plates in the condition of a dry powder (see Fig. 38). The conductor, of thin sheet lead, stamped into a shutter-like form with lips and slots, is laid upon and pushed down into the active material. Extension strips, lead-

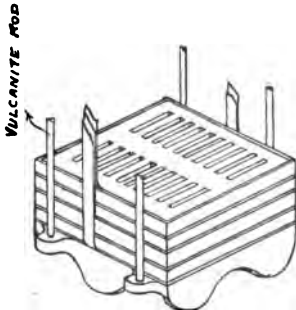

FIG. 38.

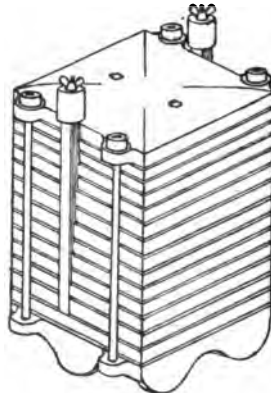

FIG. 39.

ing from the conducting plates on alternate sides, reach to the top of the cell; these strips are brought together, one-half on each side, and constitute the two terminals.

The dishes, thus filled and arranged, are stacked on top of one another, and make up the complete element, as shown in Fig. 39. A porcelain or earthenware dish is laid on top, and the whole is bound together by vulcanite rods.

<sup>1</sup> A. P., 534,603 ; 1895.

It will be seen that this arrangement effectually prevents the plates from short-circuiting, and that any tendency to buckle on the part of the conducting plates is prevented by the porous dishes. No strain of any amount can fall upon the dishes, as the conducting plates are thin, and the associated active material is in a more or less plastic condition.

Professor Langley,<sup>1</sup> of the Case School of Applied Science, tested this cell, and found that after less than 250 ampere-hours' formation, at a 12.5-ampere rate, the cell gave 3.36 ampere-hours per pound of total weight, at a 5-hour rate; the internal resistance, when charged, being 0.007 ohm.

## 2. Devices for the Retention of Paste

### (1) *Grooves or Recesses*

#### THE BRUSH GRID

To Charles F. Brush have been granted American patents<sup>2</sup> covering the broad principle of mechanical

<sup>1</sup> Professor Langley gives the following test of one of the cells:

Weight of element . . . . .	11.5 pounds.
Weight of cell, complete, with electrolyte . . . . .	18.75 pounds.
Height of cell, over all . . . . .	11.0 inches.
Width of cell, over all . . . . .	4.5 inches.
Length of cell . . . . .	5.0 inches.
Discharge current . . . . .	12.5 amperes.
Average E.M.F. . . . .	1.86 volts.
Time . . . . .	5.0 hours.
Capacity per pound total weight . . . . .	6.2 ampere-hours.

<sup>2</sup> A. P., 266,089-266,090-261,512; 1882: 337,298-337,299; 1886 B. P., 3579; 1884.

application to the support plate, no matter in what form; they also cover receptacles or perforations in the support plate. After long litigation, he was also awarded the priority of invention, in this country, of the pasted type of plate.

The form of his support plate is shown in Figs. 40, 41, and 42. The plates are cleaned chemically, and immersed either in lead acetate or lead nitrate, and

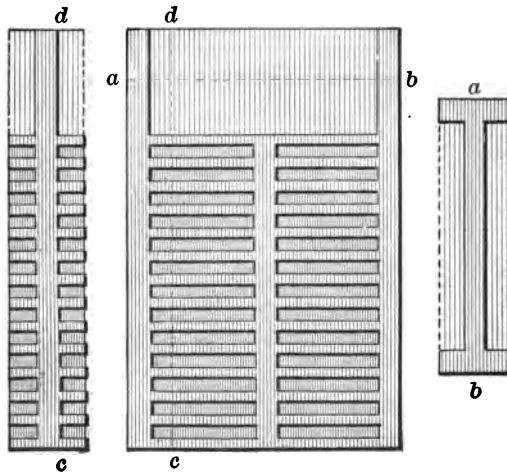

FIGS. 40, 41, AND 42.

spongy lead is deposited electrolytically. They are then washed and placed in dilute sulphuric acid until the spongy lead has been converted into peroxide, after which they are ready for use.

Another method of making the plates active is to fill the grooves with lead sulphate, place them horizontally in a solution of common salt and ammonia, with a zinc plate hung above, and short-circuit them.

## TUDOR STORAGE BATTERY

This accumulator, brought out by the Tudor Bros.,<sup>1</sup> and manufactured by The Akkumulatoren-Fabrik Actien Gesellschaft, Hagen, is much used on the Continent, especially in Belgium, and to a small extent in this country, the American patents for this battery being controlled by the Electric Storage Battery Co.

Rolled lead plates are grooved, as in Figs. 43 and 44. The thickness of the plate between opposite grooves is 3 mm. for the posi-

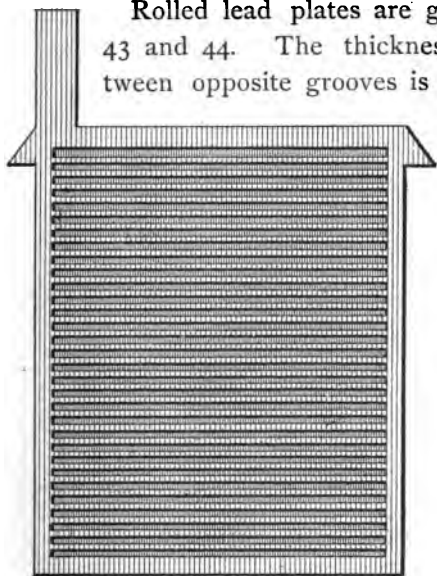

FIG. 43.

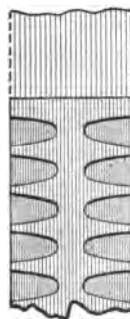

FIG. 44.

tive, and 1.5 mm. for the negative plate. The width of the grooves at the edge is 3 mm. for the positive, and 2 mm. for the negative plate; the distance between the grooves at the edge being 1.5 mm. for

<sup>1</sup> A. P., 478,661; 1892. B. P., 11,543; 1887.

both plates. The grooves are first coated with a thin layer of lead peroxide by electrolysis, and then packed with the usual oxides; after which the plates are rolled, to key in the active material. By this treatment the formation of lead sulphate at the junction of the grid and the active material is reduced to a minimum,

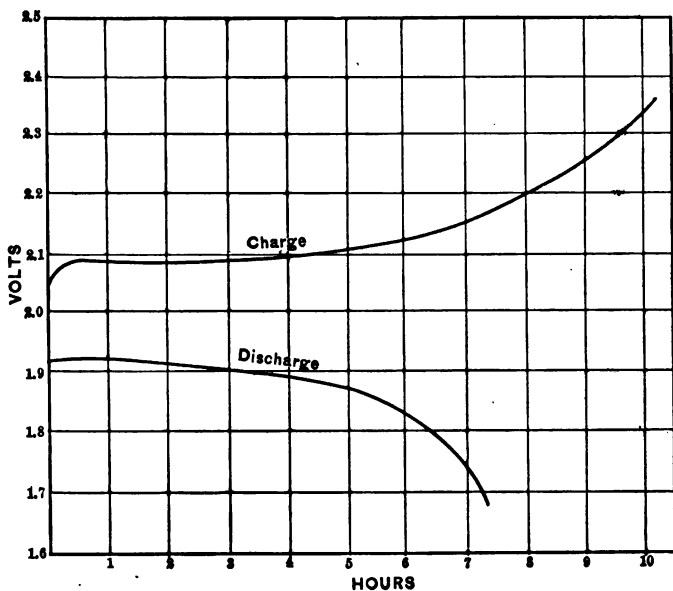

FIG. 45.

and the active material itself is less liable to scale and disintegrate. The internal resistance varies from 0.015 to 0.02 ohms. Fig. 45 gives the curve for this cell as obtained by Kohlrausch; the cell was charged at a constant current of 5 amperes, and discharged with a constant current of 6.5 amperes; the specific gravity varying from 1.115 to 1.147.



POLLAK

In this accumulator<sup>1</sup> the lead plates are covered with an electrolytic deposit of spongy lead, after which they are worked in such a manner as to produce the appearance of a short-bristle hair-brush. These hair-like protrusions are about 2 mm. long, with a space of about 1 mm. between the points. They are then coated with electrolytic lead, washed, and covered with a mixture

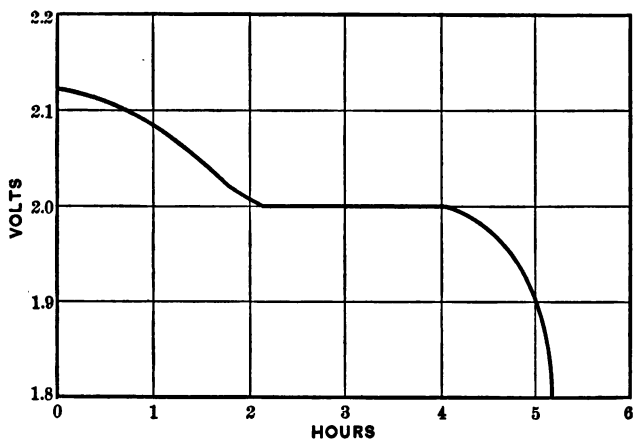

FIG. 46.

of lead sulphate and salt water. After being pasted, they are packed between zinc plates in an acid bath, and the sulphate is reduced to spongy lead. After the sulphate is thoroughly reduced, the plates are rolled so as to bend the hair-like rods, and key the active material in place. The forming charge lasts about 45 hours.

<sup>1</sup> B. P., 7428; 1889. G. P., 67,290-73,548; 1892.

Fig. 46 shows the curve of a 9-plate cell, total weight 24.75 pounds, which was discharged at a constant current of 18 amperes.

#### WOODWARD

In the manufacture of these elements<sup>1</sup> a lead plate is moulded with some substance, usually rock salt, which is afterwards removed. This leaves a plate having a highly porous surface. The active material is then pressed into the cells and pores.

#### BUCKLAND

An element for this battery<sup>2</sup> consists of a plain cast lead plate, containing holes and slots, in the latter of which are secured projecting pieces of some acid-proof, non-conducting material, such as ebonite. These projecting pieces form, with the plate, horizontal troughs, in which the active material is placed in the form of a paste. By this means no part of the lead grid is exposed to the action of the electrolyte, it being protected by the active material and by the supporting troughs.

#### KHOTINSKY

Figs. 47, 48, 49, and 50 show the plate brought out by Captain de Khotinsky,<sup>3</sup> of Holland; Fig. 48 showing the cross-section of the inner plates, and Fig. 49

<sup>1</sup> A. P., 392,373-392,374-393,954-393,955; 1888: 406,969; 1889.

<sup>2</sup> A. P., 550,480; 1895: 556,660; 1896.

<sup>3</sup> A. P., 345,511-347,231; 1886. B. P., 4490-4756; 1882: 3261-8416; 1885: 17,160; 1891.

that of the end plates. These plates are cast under a pressure of about 300 atmospheres. For a rapid discharge, the ribs are made much shorter than where a slow rate is to be employed, and the positive plates contain more ribs than the negatives. For a slow discharge, the 8-hour rate, the positive and negative plates contain an equal number of ribs; but in both cases the ribs on the positive are thicker than those on the negative plates. The plates are covered on both sides with parchment paper, asbestos, or thin perforated celluloid sheets.

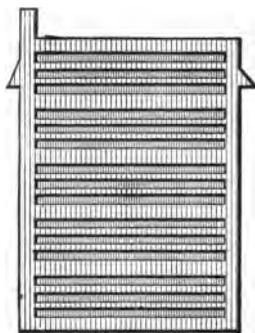

FIG. 47.

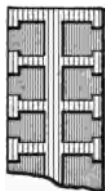

FIG. 48.



FIG. 49.

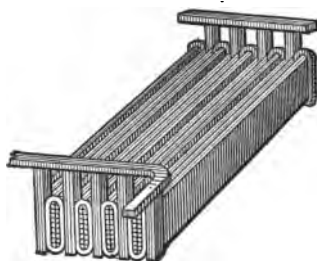

FIG. 50.

## LLOYD

Robert McA. Lloyd<sup>1</sup> treats lead plates with a hot nitric acid bath. This produces a "honeycomb" structure in the surface of the plate, which is then filled with active material.

<sup>1</sup> A. P., 491,684; 1893. B. P., 8534; 1890.

*(2) Perforations*

As stated before, the holes or perforations in lead plates may be of three general types: *a*, where the diameter is the same throughout; *b*, where it is larger at the surface than at the centre; and *c*, where it is larger at the centre than at the surface. Of these three general types, the second is undoubtedly the worst, since the plugs of active material, having nothing to hold them in place, tend to become loose and fall out, especially during a heavy discharge; while the opposite shape, or the last, is the best. Of these three general types, the Van Emon<sup>1</sup> may be used to illustrate the first, the Rooney,<sup>2</sup> the second; and the majority of perforated plates the third; although the Rooney may as correctly be classed with the third type, because of the methods employed to hold the active material in place. According to a United States Court decision, to James W. Swan<sup>3</sup> belongs the honor of originating the perforations which extend entirely through the plate.

## THE E.P.S. GRID

The patents<sup>4</sup> taken out by Messrs. Sellon, Volckmar, King, Parker, Swan, and others, combined with Faure's<sup>5</sup> patents, cover what is known as the E.P.S. battery, manufactured by the Foreign and Colonial Electric Power Storage Co. of England. The grid in

<sup>1</sup> *Vide* p. 55.

<sup>2</sup> *Vide* p. 55.

<sup>3</sup> A. P., 312,599; 1885. B. P., 2272; 1881.

<sup>4</sup> A. P., 259,657; 1882: 321,759-324,597; 1885: 454,187; 1891. B. P., 4781; 1887: 24,127; 1892.

<sup>5</sup> *Vide* p. 49.

its latest form is made of pure lead with perforations, the shape of which is shown in Fig. 51. A thin perforated strip of metal runs across each aperture midway between the edges.

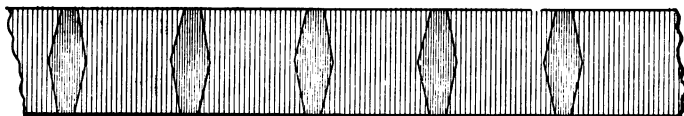

FIG. 51.

The paste, composed of minium and dilute sulphuric acid for the positive; and minium, litharge, and dilute sulphuric acid, or a solution of magnesium sulphate for the negative, is pressed into the grid and dried. The plates are then hardened in dilute sulphuric acid, after which they are ready for forming. A strong current for 48 hours is required for the positive, and 24 hours for the negative plates. To prevent short circuits, a hard rubber ring is placed around the negatives, or glass rods are placed between the plates. The internal resistance of this battery at 9 amperes is 0.0045 ohm, and at 10 amperes, 0.0038 ohm; 9 amperes being the normal discharge rate of the cell tested. Fig. 52 gives the results of a complete test of this battery.

In a cell put upon the market by this company in 1897, for autocar purposes, and designed by Camille Faure and Frank King,<sup>1</sup> the weight, as compared with the E or EK type, has been reduced fully one-half. A grid very similar in form to the ordinary E.P.S. grid is used. This pasted grid is first wrapped in a cloth of

<sup>1</sup> A. P., 501,728; 1893: 544,673-552,425; 1895: 568,447; 1896.

silicated asbestos, and then placed in a close-fitting envelope of perforated celluloid. The envelope is held to the plate by means of celluloid pins, which are

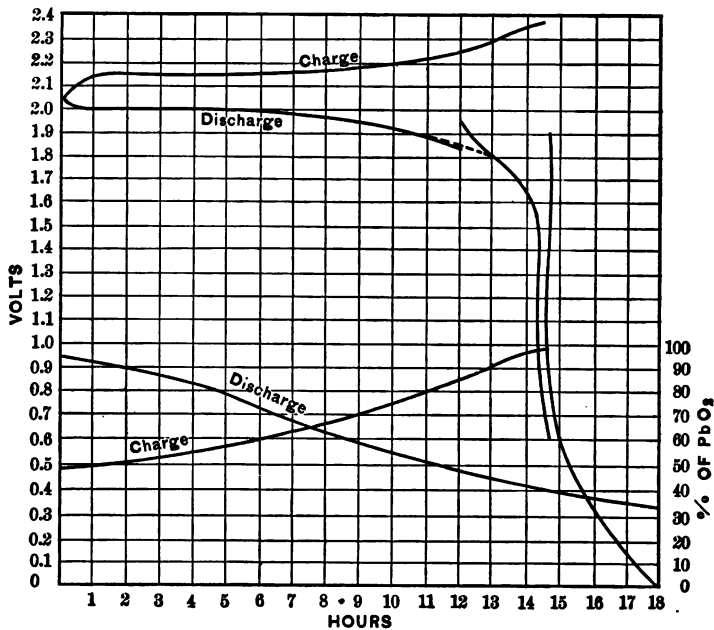

FIG. 52.

cemented on either side to celluloid diamond-shaped washers, the pins taking different positions on the positive and negative plates.

## EICKEMEIER

In this accumulator,<sup>1</sup> a flat lead foundation is pierced with polygonal holes. (See Figs. 53 and 54.) The active material, packed around plugs, is inserted in these holes,

<sup>1</sup> A. P., 413,339; 1889.

and the plugs are afterwards removed. An insulating plate, having its holes considerably smaller than those in the leaden plates, is placed between the elements; this prevents the active material from overlapping and short-circuiting by contact with an adjacent plate. Each vertical line of holes constitutes a chamber containing

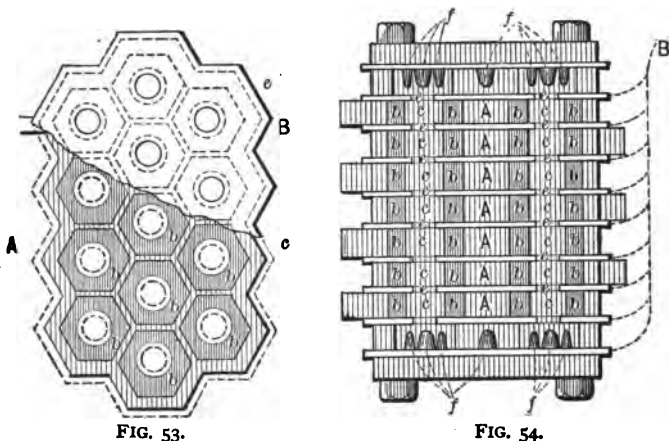

FIG. 53.

FIG. 54.

the electrolyte; the various chambers being connected by channels in the base plate (see *f*, Fig. 54), so that the electrolyte has a constant circulation through the battery. The chambers are filled by means of a funnel which fits tightly in the feed aperture at the top. The lead grid is thus protected from all action by the electrolyte, except through the active material.

## SCHENEK-FARBAKY

The positive plate for this type of cell<sup>1</sup> consists of a lead frame with a trellis formed of circular intersect-

<sup>1</sup> A. P., 344,959-348,625; 1886: 359,248; 1887.

ing bars; thus giving polygonal holes which are filled with active material. The smaller holes between two of the intersecting arcs are left open in order to regularly interrupt the continuity of the packing mass.

The active material for the positive plate contains 47.5% each of minium and litharge, and 5% of coke, treated with dilute sulphuric acid (10-15%); that for the negative plate, 95% litharge, and 5% coarse powdered pumicestone, with dilute sulphuric acid (10-15%). The grids are filled with this paste and are partially dried. The surplus paste is then scraped off, the plates are entirely dried in air, are moistened with dilute sulphuric acid, and again air-dried; are placed in sulphuric acid for from 10 to 12 hours, and finally air-dried. The elements are bound between paraffined wooden rods. The internal resistance of this cell averages 0.001 ohm.

#### VARIOUS TYPES

In the Drake and Gorham<sup>1</sup> grid a double dove-tail, shown in Fig. 55, is obtained by passing the grid be-



FIG. 55.

tween rollers. The Jacquet<sup>2</sup> plates are shown in Figs. 56 and 57. In making these grids, Jacquet casts them entire from a white metal alloy. To facilitate removal, the plates are not burned together, but are bolted to

<sup>1</sup> B. P., 3986; 1888: 17,655; 1895.

<sup>2</sup> B. P., 18,028; 1889.



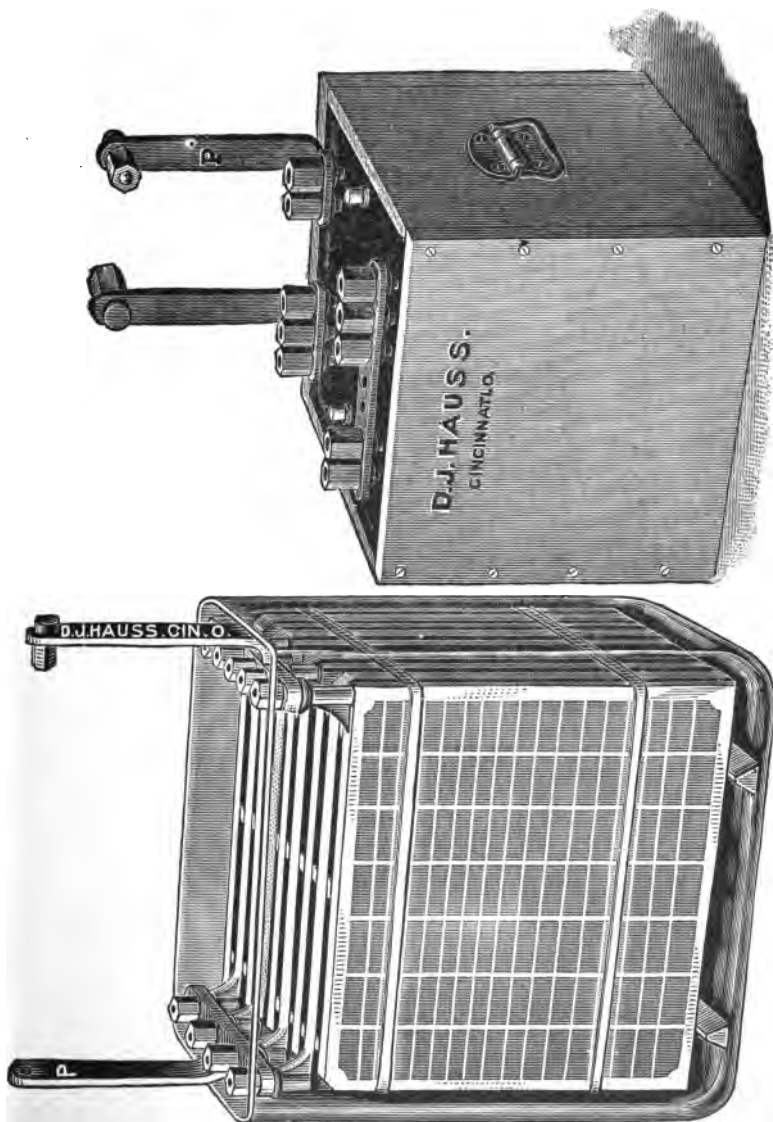

FIG. 60

FIG. 59

## THE STORAGE BATTERY

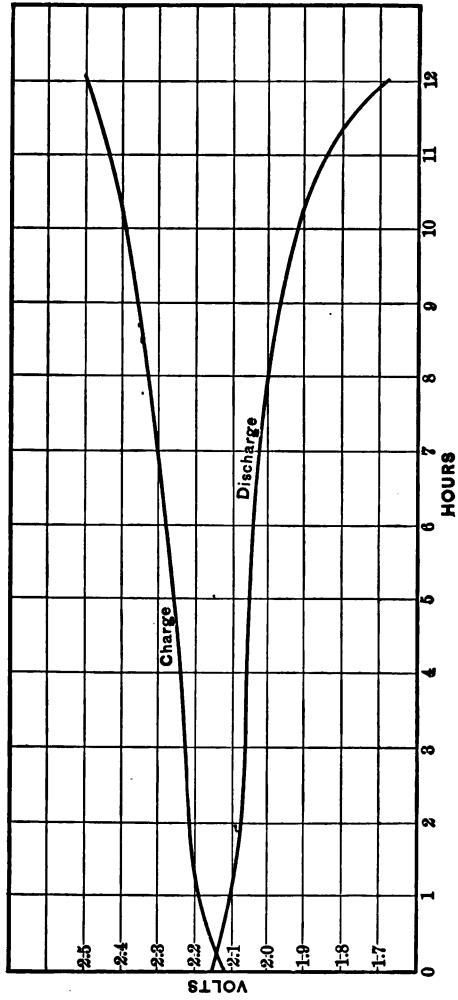

FIG. 61.

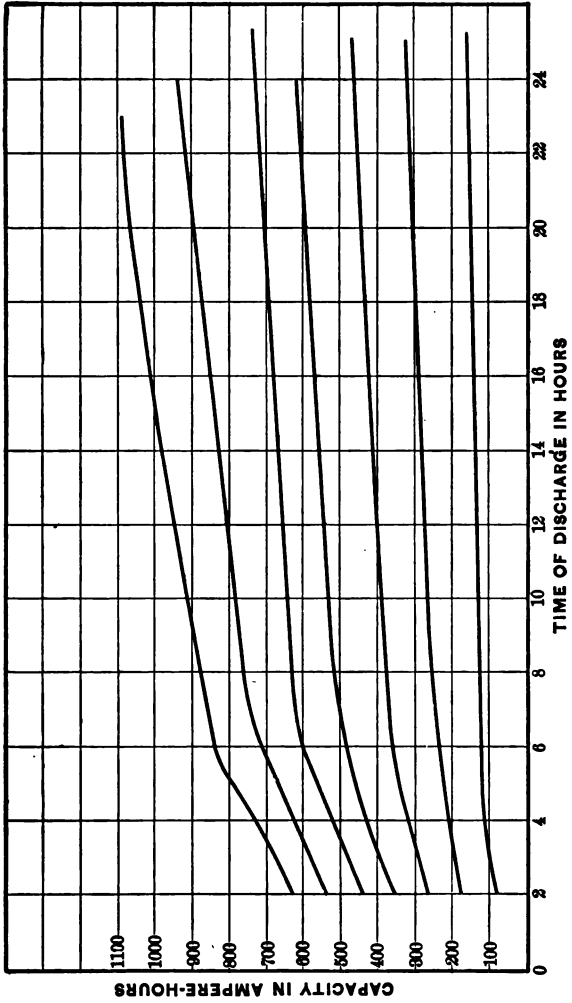

FIG. 6a.

a cast white metal pole piece. The Gibson<sup>1</sup> battery, shown in Fig. 58, consists of a lead plate, whose perforations contain buttons with enlarged heads. The active material is packed around these buttons. Figs. 59 and 60 show the D. J. Hauss plate. As will be seen,

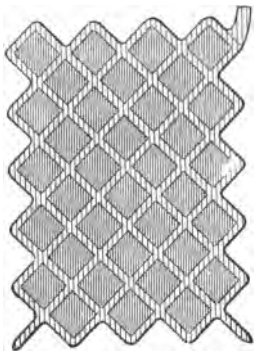

FIG. 56.

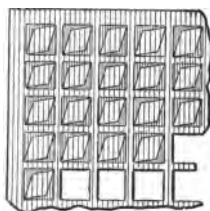

FIG. 58.



FIG. 57.

it consists of an ordinary perforated pasted lead grid. The active material is made by mixing sulphate of calcium, or the sulphates of other light metals with the litharge and alkaline solution, so as to form a plastic mass. This is tempered in a slightly acid solution, and then packed in the grids, and the pasted plates formed in a saline solution. Fig. 61 shows the curve for this plate, and Fig. 62, the relation between the capacity and discharge rate.

<sup>1</sup> A. P., 388,668; 1888: 397,796; 1889: 439,240; 1890.

(3) *Active Material surrounded by Conducting Material*

TOMMASSI

The latest form of this cell<sup>1</sup> consists of a perforated conducting tube, filled with the active material, and containing a conductor *B*. (See Fig. 63.) An insulating plate *A* is placed at the bottom of this tube, which is usually made rectangular in form. The active material for the positive electrode is composed of a lead oxide, mixed with dilute sulphuric and phosphoric acids to form a paste. Precipitated or spongy lead is used for the negative. Short-circuiting between two adjacent tubes is prevented by means of insulating perforated retaining walls. In the older forms the tubes were made of insulating material, and the conductor was given the

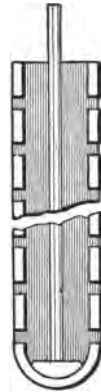
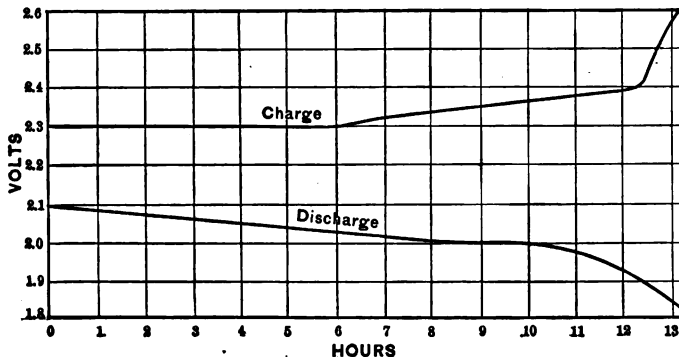

FIG. 63.



Discharge Curve of Bradbury-Stone Battery. Class B 2, (3).

FIG. 64.

<sup>1</sup> A. P., 454,091; 1891.

shape of a screw, or rod with branching arms. The formation of the Tommassi elements is said to require 220 hours.

## CORRENS

In this accumulator,<sup>1</sup> as will be seen from Fig. 65, the two frames are composed of lattice work, and are

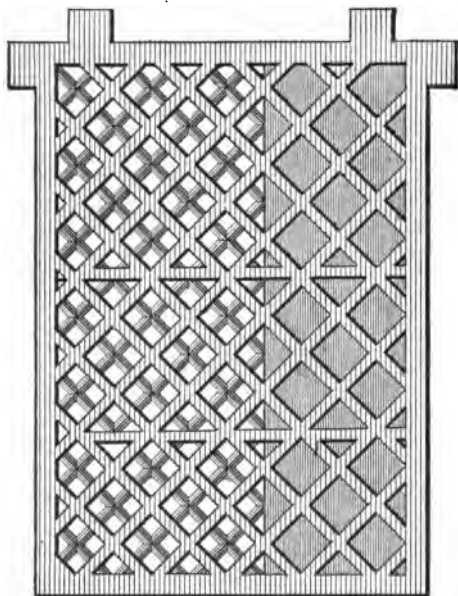

FIG. 65.

so placed that no two interstices fall opposite one another. The two frames are connected by means of small rods. The active material, minium for the positive, and litharge for the negative, contain a lead silicate, neutralized with ammonium chloride, and magnesia or white clay.

<sup>1</sup> G. P., 51,031; 1888: 52,853; 1889: 54,371; 1890: 63,433; 1891.

## FORD-WASHBURN

In this accumulator, which is manufactured by the Ohio Storage Battery Co.,<sup>1</sup> of Cleveland, Ohio, the elements consist of a flat bar of lead for the positive pole, placed within a perforated conducting cell of sheet lead; the cell being filled with lead dioxide. The conducting cell is placed within a non-conducting porous chamber, usually of earthenware. The space between

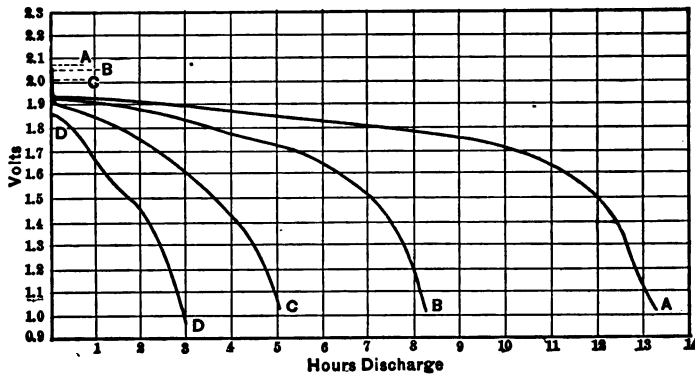

FIG. 66.

the lead conducting cell and the porous non-conducting cell is also filled with lead dioxide. Outside of the earthenware cell is placed another perforated lead conductor, having the space between it and the earthenware cell filled with litharge. These two lead conductors form a single element. The electrolyte consists of dilute sulphuric acid, containing, by weight, 1.49% of sodium sulphate.

<sup>1</sup> A. P., 451,541; 1891: 488,233; 1892.

Professors Langley and Mayberry gave this battery a thorough test. They found that during a two months' test, neither heavy charges or discharges, nor a prolonged course of vibration, imitating that of a street car, produced any measurable deterioration of the battery; the internal resistance during the entire test averaging 0.0048 ohm. Fig. 66 shows the curve obtained by them from a 5-element cell, the total weight of the battery being 70 pounds, and that of the elements 42 pounds. The battery was discharged with a constant current, the rates being 10 amperes for curve *A*, 15 amperes for *B*, 20 amperes for *C*, and 30 amperes for *D*.

#### VAN GESTEL

Van Gestel<sup>1</sup> uses a lead tube, perforated, and filled with active material. A lead-covered copper conducting wire passes through the centre of the tube, which is bent upon itself, until it forms, practically, a square plate.

#### JOHNSON AND HOLDREGGE

In this battery,<sup>2</sup> perforated lead plates, which are ribbed only on one side, are covered on that side with active material. Two plates are then taken, and so bolted together that their ribbed sides are adjacent. Conical steel pins are placed in the perforations of the plates, before the introduction of the active material, and are removed when the plates are thoroughly dry, thus giving the electrolyte free access to the active material.

<sup>1</sup> A. P., 358,092; 1887. B. P., 12,376; 1888.

<sup>2</sup> B. P., 13,274; 1893.



## SOLA-HEADLAND

This plate<sup>1</sup> is composed of perforated rectangular lead tubes, into which the active material is pressed. The makers claim that since equal surfaces are exposed on the four sides to the current, buckling is impossible, even on short circuits. The ratio of the weight of the active material to the total weight of the plate is less than 50%. These batteries have been introduced in London for the propulsion of autocars.

*(4) Active Material surrounded by a Non-conducting Material*

## REYNIER ELASTIC

Reynier,<sup>2</sup> in his latest sulphuric acid cell, has endeavored to so construct the elements as to permit them to expand or contract during charge or discharge, without damage to themselves. To accomplish this, the plates are separated by porous sheets of silica, which, he found, only slightly increased the internal resistance. Each element contains one positive and two negative plates, and four sheets of silica, the end sheets being fluted to increase the available space for the electrolyte. The containing vessel is made of pure lead, surrounded by an expansible corrugated case. The plates themselves are made from a very fine lead wire net, slightly compressed into the desired shape.

In the latest type, the cells are composed of a number of elements in series, placed between two rigid end

<sup>1</sup> B. P., 15,120; 1892.    <sup>2</sup> A. P., 438,827; 1890. F. P., 181,698; 1887.

pieces, which are drawn together by means of strong india rubber springs. Owing to the action of these springs, expansion and contraction of the elements can take place freely without causing disintegration.

#### BARBOUR-STARKEY

Mr. Barbour-Starkey<sup>1</sup> simply makes the cells of the ordinary form solid by filling in the space between the plates and the cell with a dry mixture of sawdust and plaster of Paris, in the proportion of 25 : 10, and then saturating the mixture with dilute sulphuric acid. A non-resinous sawdust is found to be the best. Mr. Barbour-Starkey claims that this method of treating cells will effectually prevent all warping and buckling, and will preserve the plugs of active material from being detached. Recently a battery of E.P.S. traction cells were treated in this way, and then put to regular work. A loss of current capacity and general inefficiency was experienced, and the battery had to be ultimately abandoned.

#### OERLIKON

In this cell, brought out by Dr. Schoop,<sup>2</sup> the amount of active material on the grids is only about two-thirds as great as in the ordinary type. In the manufacture of the electrolyte, dilute sulphuric acid, specific gravity 1.250, is mixed with dilute sodium silicate, specific gravity 1.180, in the proportion of 3 : 1. When freshly made, this mixture is quite fluid, but it gradually solidi-

<sup>1</sup> B. P., 15,754; 1887: 7619; 1889.

<sup>2</sup> A. P., 529,199; 1893. B. P., 7719; 1889.

fies, and in about 24 hours it becomes a hard, jelly-like mass, having a slightly bluish tinge. When bubbles of gas are formed, as they sometimes are, they simply push the gelatine aside and escape. When fully charged, a small amount of acid is forced out, and floats on top, the acid being again absorbed during discharge.

This cell has received some very elaborate tests by Dr. Kohlrausch, at the Hanover University, showing very good storage capacity. Dr. Kohlrausch believes that, by the use of this gelatinous electrolyte, the cells may be in constant use for two years, giving their full current capacity, and that they may be used for another year with excellent results.

#### PUMPELLY

In this battery<sup>1</sup> the grids are placed horizontally. They are cast with stout legs on one side, so constructed as to bear the entire weight of the plate. The legs also serve as conductors between plates of like polarity. In building up a cell, the bottom plate is laid upon a foundation of cellulose, or wood-pulp fibre. The interstices of the grid are then filled with red-lead or litharge, according to the polarity of the plate. The requisite hardness of the active material is obtained by hand pressure. Upon this plate is placed another layer of cellulose or fibre, then another grid, packed, and so on. The cell is then filled with the electrolyte until the packing is thoroughly saturated, considerable free liquid being left in the cell.

<sup>1</sup> A. P., 416,299; 1889: 442,390-442,391; 1890.

## THERYC-OBLASSER

In the manufacture of this battery<sup>1</sup> a perforated envelope of celluloid, or similar material, is filled, while in a plastic condition, with the oxides to be used, a core of lead-antimony being placed in the centre. The opening is then closed, and the whole is subjected to heavy pressure. The core is thus protected from all electrolytic and chemical action.

## THE HESS STORAGE BATTERY

This battery<sup>2</sup> differs from other existing types, through the employment of a double electrode. In the construction of the battery, lead plates containing square perforations are used. These perforations and one side of the plate are covered with an extremely porous non-conducting material, composed of quartz sand, held together by asphalt. Two plates are placed side by side, about  $\frac{1}{8}$  of an inch apart, with their exposed lead surfaces facing each other, and so arranged that the exposed lines, both vertical and horizontal, are half a space removed from the corresponding lines on the other plate.

The plates are provided with projecting ribs, and are cemented around the edges, thus forming a pocket for the introduction of the active material. The elements are then assembled, the double electrode representing one element. Hard rubber strips, with buttons at

<sup>1</sup> A. P., 500,978-502,643; 1893. B. P., 5059-24,834; 1895.

<sup>2</sup> A. P., 525,017-525,018; 1894.

intervals of 2 inches, are used as separators, leaving a clearance space of  $\frac{1}{8}$  of an inch between the electrodes.

The assembled elements are now placed in the containing cell, and the electrolyte is introduced, after which they are ready for the introduction of the active material. This is accomplished by means of an appliance called a conveyer. The conveyer forces the active material into tubes or conductors, which register with the pocket of each electrode. The internal resistance of this battery, as obtained by Houston and Kennelly, varies from 0.0038 to 0.008 ohm.

The manufacturers claim for this battery, that it is the only one in which there are no exposed metallic surfaces; that the conducting plates are protected from consumption; that there is no possibility of the active material becoming disintegrated and falling out; that the active material obtains a degree of porosity impossible with other batteries; and that buckling or warping is absolutely prevented. In a cell containing 15 plates, each 9 inches square, the total surface for each electrode is 7.875 square feet.

#### THE ACME BATTERY

In this battery, which was brought out by Kennedy and Diss,<sup>1</sup> each plate consists of a thin, slotted sheet of rolled lead, which is covered on both sides with active material. The active matter is held in place by perforated plates of insulating material, placed on each side of the plate. Bolts at the corners hold all the elements together.

<sup>1</sup> A. P., 482,043-482,044; 1892.

## GÜLCHER

Gülcher<sup>1</sup> uses a frame of parallel lead wires, around which he weaves elastic glass wool, the method of weaving resembling that of a wicker basket. The active material is held in a finely divided state on the lead wires by means of the glass wool. The plate is saturated with a concentrated solution of lead acetate and dilute sulphuric acid, and is placed between zinc plates, covered with filter paper, and placed obliquely

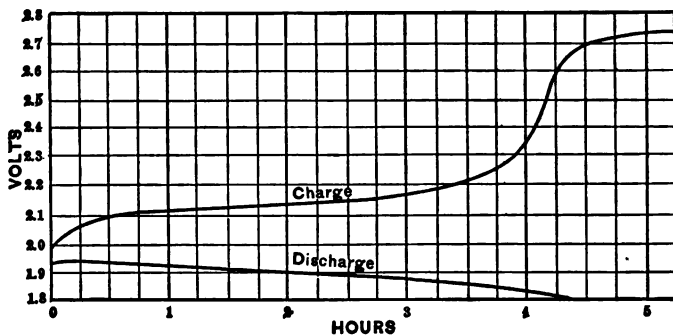

FIG. 67.

in salt water or very dilute muriatic acid for forming. His patent reads: *electrodes for electric accumulators, comprising a fabric made of lead threads as warp, and glass or quartz threads as woof, a frame of lead, and a covering of spun glass.*

These plates were tested for traction purposes by two large German firms, and it was found after three months of hard usage that the plates were uninjured and their

<sup>1</sup> B. P., 6947; 1894. A. P., 562,396; 1896.

capacity unchanged. Fig. 67 shows a curve taken from a 40 A. H. cell charged with a constant current of 7.4 amperes and discharged through a constant resistance. The average discharge current was 7.58 amperes.

#### KOWALSKI

The Kowalski, or I. E. S. plate, which is manufactured by the International Electric Storage Co. (Ltd.), of London, consists of a perforated envelope of celluloid, in which is placed an electrode consisting of a number of antimonous lead wires. The space between the electrode and the envelope contains paper pulp and pulverized oxides of lead. These are soaked in an electrolyte, whose composition is kept a secret. The liquid is absorbed by the powder, and after the electrode has been immersed for 24 hours it is removed and dried, and is then a compact mass. This battery is used on 50 cars on a French railway for lighting.

#### RIBBE

This grid<sup>1</sup> consists of a sheet of rolled lead  $\frac{1}{16}$  of an inch thick, with elongated perforations. It is coated on both sides with active material, which fill the perforations and make a uniform layer. The grid is then covered on both sides with ribs of celluloid of a conical cross-section, about 4 mm. in breadth, so as to divide the surface of the plate into long narrow rectangles. Each pair of adjacent ribs on opposite sides of the grid are cemented by acetone solution at inter-

<sup>1</sup> A. P., 553,596; 1896.

vals through holes in the grid. In order to further secure the active material in close contact with the grid, finely perforated plates of celluloid are cemented to the free surface of the ribs. Each plate then consists of a continuous lead core, a layer of active material on each side, and a close fitting cover of perforated celluloid, which is strengthened at intervals by vertical ribs, the ribs being cemented together through the grid.

#### HASCHKE

This plate is made from chemically pure sheet lead, perforated with holes  $\frac{1}{8}$  of an inch in diameter and  $\frac{1}{8}$  of an inch apart. The plates are first slightly disintegrated by chemical action, and are then pasted with the active material. The positive plates are about three times as thick as the negative plates. Each positive plate is enveloped by specially prepared insulating material. The plates are then assembled and enveloped by stout rubber bands, the plates being separated from each other only by the thickness of the insulation ( $\frac{3}{16}$  inch). The positive plates rest on the bottom of the containing cell, the negatives being held  $\frac{1}{2}$  inch above the bottom by the compactness of the elements.

The insulating medium of this battery is specially prepared cardboard, subjected to an electro-chemical process. Certain chemicals, the composition of which is a secret, are decomposed by electrolysis in a containing vat, and the gases therefrom rise and saturate the insulation. A current of 35 amperes at 20 volts is used to vaporize or treat 45 sheets of this board, each sheet



being 26 inches by 16 inches in size. In Fig. 68 are given some interesting curves, *A* being taken from a 250 A. H. cell, and *B* and *C* from a 100 A. H. cell. The curve *C* was obtained during the burning of a  $\frac{3}{4}$ -inch hole through a 2-inch sheet of steel.

In 1897 Mr. Haschke overhauled the old New York Accumulator Co.'s cells in the family residence and

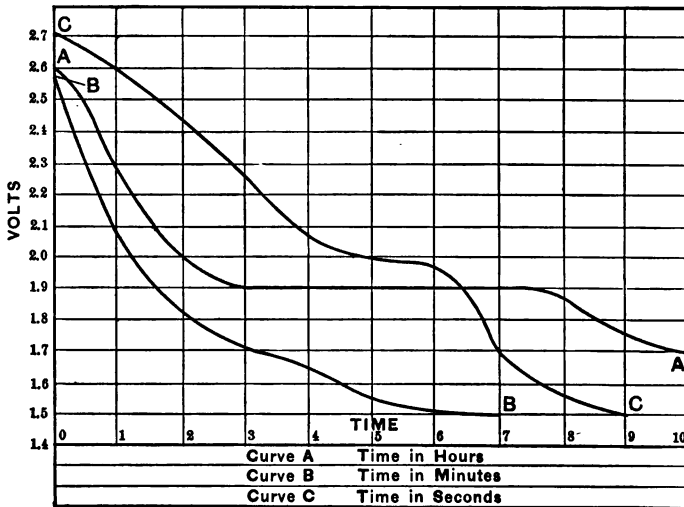

FIG. 68.

hotel of Mr. Potter Palmer, of Chicago. The small amount of active material remaining in the cells was removed; and after the plates had been subjected to heavy pressure they were repasted, and the positives were wrapped in the insulating material just described. The plates are now in excellent condition, and are believed by many to be better than when new.

### 3. Devices for Securing Better Contact

#### BRUSH

In his patents, Brush<sup>1</sup> specifies the use of pressure sufficient to "weld the packing mass" to the support plate. In the manufacture of his battery, spongy lead is deposited electrolytically before the application of the active material. A current is afterwards passed, thus forming a coherent mass of the active material and the support plate.

#### TUDOR

In the Tudor<sup>2</sup> element, the plate is first oxidized, either wholly or in part, before the application of the active material. This method has the advantage that the plate itself supplies active material to replace that lost in the cell.

#### PAGET

In the method brought out by Dr. Leonard Paget,<sup>3</sup> and used by the MacReon Storage Battery Co., fused lead oxide is subjected to the action of a reducing agent, such as carbon mixed with nitre. This reducing agent is placed in the mould in such a manner that when the fused substance is poured in, metallic lead is produced by the reducing agent, thus giving a perfect union between the active material and the support plate.

<sup>1</sup> A. P., 262,523; 1882: 264,211; 1882.      <sup>2</sup> A. P., 413,112; 1889.

<sup>3</sup> A. P., 397,607; 1889.

## VARIOUS METHODS

In addition to the three methods mentioned above might be given those due to James,<sup>1</sup> Pollak,<sup>2</sup> and Grout, Jones, and Sennet.<sup>3</sup>

<sup>1</sup> *Vide* page 50.

<sup>2</sup> *Vide* page 63.

<sup>3</sup> G. P., 21,376.

## CHAPTER IV

### 1. The Prevention of Buckling

RECKENZAUN

THESE plates<sup>1</sup> are formed of tubes made from porous compressed active material (see Fig. 69). The tubes are

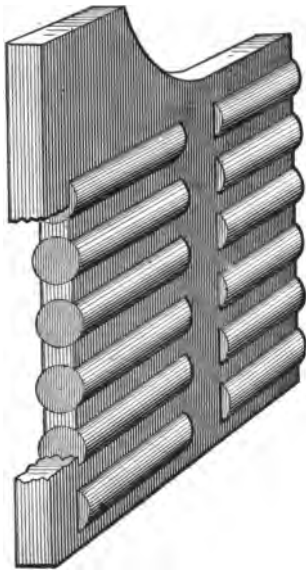

FIG. 69.

placed in a mould, and pure molten lead is poured around them to form a plate  $\frac{1}{8}$  of an inch thick. The space between the tube is  $\frac{1}{16}$  of an inch, the diameter of the tubes being  $\frac{3}{16}$  of an inch, and their length  $1\frac{1}{8}$  inches.

In another form of plate<sup>2</sup> an arc is passed between the plates and an arc carbon, thus transforming the surface of the plate into peroxide to any desired depth. By this method an amount of chemical combination is produced in a few minutes that it would take days to produce by the slow process of electrolytic action. It has been found that

<sup>1</sup> A. P., 385,200; 1888.

<sup>2</sup> A. P., 475,797; 1890.

when the oxides are formed in this manner they do not show any disposition to scale or fall off when placed in an acid bath, or when subjected to electrolytic action.

The object in view in both of these methods is to produce a plate whose expansion will be in the direction of the axis rather than at right angles to it.

#### HERING

This battery<sup>1</sup> contains but four elements, two positives and two negatives, as in Fig. 70. The two outer plates are composed of solid blocks of lead peroxide, and the two inner ones of spongy lead. The peroxide plates are made by mixing dry powdered lead peroxide, minium, and lead carbonate or sulphate, with a solution of acetate of lead to a stiff paste. The paste is then pressed into a mould and allowed to dry. Plates of conducting material are placed against the flat sides of these porous blocks. Perforated strips of non-conducting material pass over both sides of the electrodes, thus securing good contact between the conducting material and the porous blocks, and at the same time securing the elements against short circuits.

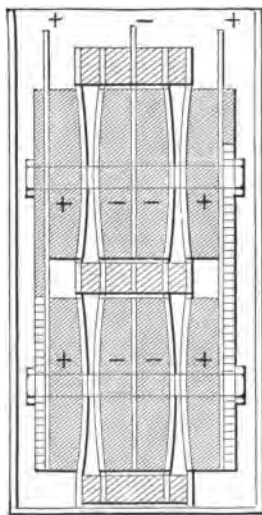

FIG. 70.

<sup>1</sup> A. P., 429,272-429,273-429,274; 1890.

Instead of using the usual sulphuric acid electrolyte, Mr. Hering prefers sodium or potassium sulphate in the acid. By this means the local action is greatly reduced. This battery, although not on the market, is an excellent one, the buckling or warping being almost entirely stopped.

#### THE BLOT ACCUMULATOR

This plate, the invention of M. G. R. Blot,<sup>1</sup> is of the Planté type, and contains no pasted oxides whatever. Each plate is made up of several longitudinal coils of lead ribbon (see Figs. 71 to 75), the planes of which are perpendicular to that of the plate. The windings of these coils are alternately of embossed and corrugated lead ribbon wound round a shuttle, and so fixed as to be free to expand. The thickness of the ribbons and the shuttle varies according to the capacity of the cell and the rate of charge or discharge required. Only the lower ends are soldered to the frame. The plates are suspended in a somewhat complicated frame, in which they rest on glass, and nowhere do they touch the bottom of the cell.

The manufactures claim: (1) the maximum electrical surface obtainable, the surface being one-third of a square meter for each kilogramme of plate; (2) rapid charge and discharge, the cells being able to stand a rate of 18 amperes per kilogramme of plate, and having been charged at constant potential in one hour; (3) absolute immunity from buckling, even on short circuit; (4) absolute and efficient conductivity between

<sup>1</sup> A. P., 535,885; 1895.

the frame and the active material; (5) durability and low first cost.

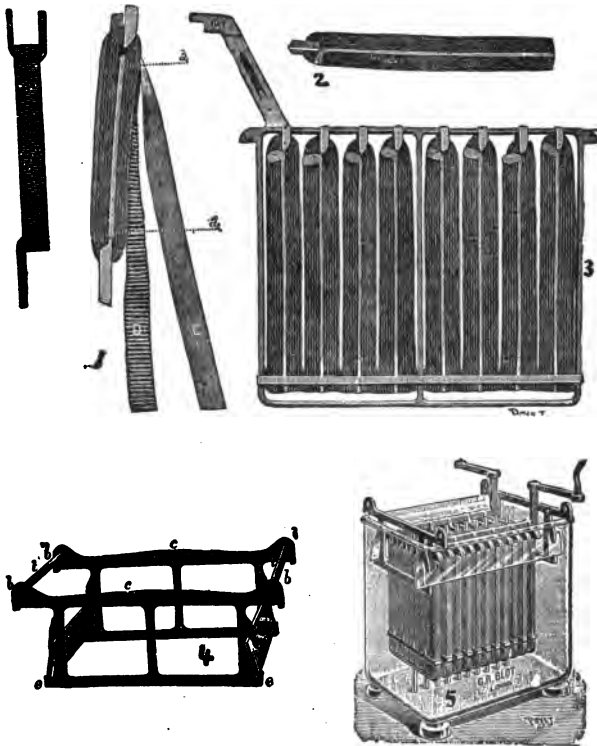

FIGS. 71 TO 75.

#### MONTERD

In this battery, the plates consist of concentric cylinders, one side of which is grooved, and contains the active material.

## 2. The Preparation of Active Material

### SORLEY

Sorley<sup>1</sup> prepares his active material by taking a lead oxide, treating it with sulphuric acid to produce expansion, and afterwards drying with heat.

This, it may be noted, is the usual method of preparation.

### HOUGH

Hough<sup>2</sup> prepares his active material as follows: a mixture of dry monoxide of lead and sulphate of magnesia is first formed; this is reduced to a paste by mixing with ammonium sulphate and water. The plates are coated with the paste, after which the magnesium sulphate is eaten away.

### SILVEY

In one of his batteries Silvey<sup>3</sup> uses for the negative plate a paste composed of a low oxide of lead, finely divided metallic lead, and superficially oxidized particles of metallic lead, and water; for the positive, sulphuric acid and water, a high oxide of lead, finely divided metallic lead, and superficially oxidized particles of metallic lead.

### KRECKE

In a note in the *Elektrotechnischer Anzeiger*,<sup>4</sup> it was stated that Krecke has succeeded in producing a very hard mass by mixing lead oxide with tannic

<sup>1</sup> A. P., 419,728-423,091; 1890. <sup>2</sup> A. P., 512,283; 1894; 535,541; 1895.

<sup>3</sup> A. P., 538,628; 1895.

<sup>4</sup> E. W., Vol. 28, p., 733.



acid and albumen of glue, or by mixing lead oxide with uric acid.

#### THE ENGEL SYSTEM

For the positive plate,<sup>1</sup> litharge is mixed with sulphate of magnesia, washed grease, and hydrochloric acid. For the negative plate, litharge is mixed with calomel, or bisulphate of mercury and ammonia. These materials are applied to the plate and hardened by immersion in water for several days. The plates are then formed in a solution of common salt, after which they are used in the ordinary sulphuric-acid electrolyte.

#### SCHAEFER-HEINEMAN

These manufacturers<sup>2</sup> make a paste of glycerate of lead, mixed with certain fatty acids; this is applied to a plate of the grid form. The positive plates are formed in an acid bath containing potassium permanganate, with a current density of 19 to 25 amperes per square metre. The negative plates are formed more slowly in an ordinary acid bath, without the addition of the potassium permanganate.

#### GELNHAUSEN

In the Gelnhausen or "lead-dust" accumulator, the active material consists of lead-dust and powdered pumicestone, thoroughly mixed and moistened with water. As this material shows a decided tendency to set, the pasting must be done quickly.

<sup>1</sup> B. P., 16,162; 1894.

<sup>2</sup> G. P., 80,420-82,787-82,792; 1894.

## GRUENWALD

Gruenwald makes his active material by mixing pulverized lead with linseed oil and borate of magnesium. Formation changes the oil into a resinous substance, which constitutes the binding material.

## CHAPTER V

### BATTERIES IN WHICH ONE OR BOTH ELECTRODES ARE OF SOME OTHER METAL THAN LEAD

#### II. — LEAD-COPPER GENUS

THE advantages peculiar to accumulators of this type are that they are easy and economical of construction, and that they keep their charge fairly satisfactorily. The voltage, however, is low, averaging about 1.25, and the capacity per unit of weight small. These batteries are not used in commercial practice, and are of little interest save for laboratory purposes.

#### REYNIER

Reynier used an ordinary lead cell in which the electrodes were placed horizontally, the electrolyte being composed of copper sulphate.

#### MASON

Edward J. Mason<sup>1</sup> used metallic plates containing lead peroxide for the positive and iron plates coated with copper for the negative electrode. The electrolyte was copper sulphate in a solution containing free sulphuric acid.

#### SUTTON

In this battery a copper containing-vessel served as the negative electrode; the positive electrode was amal-

<sup>1</sup> A. P., 439,324; 1890.

gated lead, and the electrolyte was copper sulphate. As might have been foreseen, the copper vessel was soon eaten away. The electrodes were separated by wood.

#### ERVING

The cathode of this form of cell is of copper, connected to a sheet of zinc, and placed outside of a porous cup. The anodes are of lead with 2% of silver, placed inside of the porous cup. A paste of lead peroxide and aluminum is packed between the porous cup and the lead. The electrolyte consists of ammonia and acid bisulphate of mercury.

### III. LEAD-ZINC GENUS

Wheatstone, in 1843, appears to have been the first to have advocated the use of zinc instead of spongy lead for the cathode. Since then many investigators have taken up the problem, and have introduced secondary batteries of this kind. These have attained considerable prominence of late years, and are in commercial use to-day, although it is extremely doubtful if they will ever supersede the lead-sulphuric-acid genus in engineering work. By the use of zinc and lead peroxide, it was found that the E.M.F. was increased, but that new difficulties were introduced, principal among which was the eating away of the zinc by the electrolyte. Reynier has found, however, that if the zinc be either chemically pure, or thoroughly amalgamated, local action is reduced to a minimum. The construction of the lead-zinc cell is economical, and it is the lightest, theoretically, of all types. The capacity

in watt-hours per pound of working substance, is, according to calculation, 57% higher than in the case of the lead-sulphuric-acid batteries.

## BOETTCHER

In 1882 Emile Boettcher<sup>1</sup> constructed a cell with thin corrugated lead sheets for the positive and ordinary zinc plates for the negative electrode. The lead plates were covered with a paste of lead oxide moistened with zinc sulphate, the electrolyte being zinc sulphate, 1 : 3. The E.M.F. was 2.2 volts.

## REYNIER

M. Emile Reynier, in 1883, constructed a battery with four peroxide of lead plates of the Planté type for the positive, and three smooth sheet-lead elements, covered with chemically pure electrolyzed zinc, for the negative electrode, in an electrolyte of zinc sulphate. The total area of the positive active surface was 200 sq. dcm., and that of the negative 150 sq. dcm. The total weight of the cell was 17.16 kg., that of the elements being 9.6 kg. His cell gave 152 ampere-hours at a 6-hour rate, the average internal resistance being .02 ohm. The formation required 200 hours.

## BARKER

In this accumulator amalgamated copper and zinc plates riveted together are used for the negative electrode, and leaves of lead foil, coated with graphite and clamped together, for the positive. An acid solution of

<sup>1</sup> G. P., 21,174; 1882: 23,916; 1883.

zinc sulphate forms the electrolyte. A minimum of local action is claimed for this battery.

#### LUGO<sup>1</sup>

In the Lugo cell a negative plate of zinc, coated with a lead oxide, and a positive plate of lead, also coated with a lead oxide, are used in a solution of borate of ammonium.

#### EPSTEIN

Ludwig Epstein<sup>2</sup> sets the cathode in rotation during charge and discharge. His cathode consists of zinc amalgam, on a copper wire net, which is fastened to a conducting shaft. The anode is lead peroxide.

#### TAMINE

Tamine<sup>3</sup> places lead and zinc electrodes, similar in form to Planté plates, in a solution of 1000 parts of concentrated zinc sulphate, 500 parts of sulphuric acid (10%), 40 parts ammonium sulphate, and 50 parts of mercuric sulphate. In constructing the anodes, 20 parts of electrolytic lead peroxide, 75 parts of lead filings, and 5 parts of resin are cemented together under a pressure of 300 atmospheres.

#### THE RIVER AND RAIL SECONDARY BATTERY

In this accumulator, which was brought out by Main<sup>4</sup> and Meserole,<sup>5</sup> the positive electrode consists of a number of thin lead plates, fastened by lead rivets to thicker

<sup>1</sup> A. P., 458,424-458,425; 1891.

<sup>2</sup> A. P., 543,680; 1895.      <sup>3</sup> B. P., 12,824; 1884.

<sup>4</sup> A. P., 359,934; 1886: 401,289-401,290-401,291; 1889.

<sup>5</sup> A. P., 359,877-361,660; 1886: 381,941; 1887.

outside lead plates, all the plates containing a number of fine holes. These plates are formed in the usual Planté manner; that is, by electro-chemical action. The negative plate consists of zinc amalgam, deposited electrolytically on a tray-shaped copper plate. These plates are made in a  $\sqcup$  form, the positive plate being hung within, and separated from the negative by a hard

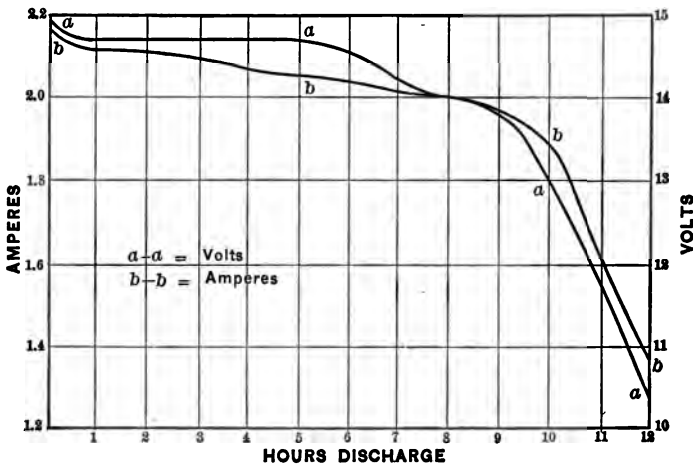

FIG. 76.

rubber ring. The electrolyte contains zinc sulphate and mercuric sulphate. In an older form, the plates were placed horizontally.

Fig. 76 shows a curve taken from one of these batteries, which contained 14 plates, and was built especially for traction purposes. The weight of the cell was 45 pounds, and that of the plates 27 pounds.

## IV. ALKALINE-ZINCATE GENUS

## LALANDE AND CHAPERON

This cell, which is known both as the Edison-Lalande and Lalande-Chaperon<sup>1</sup> accumulator, has copper oxide as one electrode, and almost anything that can be plated with zinc for the other; the electrolyte being either caustic potash or caustic hydrate. Although it is claimed that almost no local action takes place, it has been found that the zinc is actually dissolved in the solution.

Opperman gives the following method for making a very cheap copper oxide electrode. He immerses carbon plates in a saturated solution of copper nitrate for a short time, and then dries them. This operation is repeated until the plates are thoroughly saturated. They are then carefully dried and heated, slowly at first, until the copper nitrate is changed into copper oxide. Care must be taken that the copper oxide is not reduced to copper. These plates, he claims, are very porous, and consequently very active. They may be regenerated by washing with water, and air-drying for several days. With these plates, the voltage, according to Mr. Opperman, is 1.2 as against 0.8 for the ordinary electrodes.

## THOMSON-HOUSTON

The Thomson-Houston<sup>2</sup> accumulator consists of a glass vessel which is divided into two sections by a porous diaphragm placed horizontally. In each section is placed a copper electrode parallel to the diaphragm,

<sup>1</sup> B. P., 1464; 1882.

<sup>2</sup> A. P., 220,507; 1879.



and the cell is filled with a saturated solution of zinc sulphate. The capacity of this cell is claimed to be independent of the extent of surface of the electrodes, and only dependent upon the mass of the material to be acted upon. The process of charging might be described as the working of a gravity battery backwards. Zinc is deposited and copper goes into solution as copper sulphate under the action of the charging current. The duration of the charging action is only limited by the amount of zinc sulphate present, and by the thickness of the copper element. When ready for use, after charging, this cell constitutes a copper-zinc gravity battery.

#### DESMAZURE

This type of cell was first experimented upon by Lalande before he became identified with the Lalande-Chaperon battery. He did not, however, obtain any practical results. Desmazure<sup>1</sup> then took up the problem, and with the aid of De Virloy, Commelin, and Baillache succeeded in producing a secondary battery which gave fair results, but which, for various reasons, was not a commercial success. The problem of producing a commercial copper-zinc storage battery was finally taken up by Philip and Entz, who produced the cell now known as the Waddell-Entz accumulator.

In the Desmazure battery, copper mud, compressed into blocks, covered with brass gauze, and placed in a parchment envelope, is used for the positive, and iron gauze for the negative element. This copper mud is

<sup>1</sup> A. P., 345,124; 1886: 402,006; 1889.

formed into blocks under a pressure of about 1000 atmospheres; a very porous block of copper, of about two-thirds the specific gravity of sheet copper, being the result. The containing chamber is thin tinned sheet steel. The resistance of 1 sq. dcm. of electrode surface is about 0.35 ohm. The solution usually employed is composed as follows:

Water . . . . .	1000.0 parts.
Zinc . . . . .	144.67 parts.
Combined potash . . . . .	200.82 parts.
Free potash . . . . .	313.72 parts.

In the Waddell-Entz<sup>1</sup> battery the positive element is composed of copper wire gauze, surrounding finely divided copper, and enclosed in cotton bags. The negative plates are a network of fine iron wire, on which the zinc is deposited. By heating the cells to a temperature of 86° F., while charging, it was found that the copper oxide was not dissolved.

While charging, zinc is abstracted from the solution, and deposited upon the negative plates. At the same time oxygen is developed, uniting with the positive element, and forming a copper oxide. During the discharge, the reverse action occurs. Zinc from the negative element reenters into solution, and oxygen is abstracted from the copper oxide, till at length the couple becomes quite inert. It is claimed that the plates do not lose mechanical strength by the repeated chargings and dischargings.

<sup>1</sup> A. P., 421,916; 1890: 440,023-440,024; 1890: 461,823-461,858-467,573; 1891: 425,260; 1892.

BOETTCHER<sup>1</sup>

On the bottom of an iron containing-vessel, but insulated therefrom, is placed a zinc plate. About this is a heavy layer of potassium solution in zinc oxide. A block of porous copper oxide, serving as the anode, is soldered to the iron vessel. The electrolyte is a 50% solution of potassium hydroxide saturated with zinc. As the zinc is taken from the above layer, the copper is raised. The E.M.F. is 1.1 volts, and the internal resistance 0.5 ohm.

SCHOOP<sup>2</sup>

The anode consists of 64 vertical copper rods, 8 mm. in diameter. The two ends are provided with a covering of magnesia, the bottom covering serving to insulate the electrode from the containing-vessel, and as a support for the surrounding diaphragm. A parchment paper, or cotton-wool envelope, is fastened to the magnesia rods by cotton-wool threads. The steel containing-vessel is divided into 64 square cells, by steel plates. In these stand the copper rods, their tops being connected to a copper plate. Zinc is deposited on the steel sheets. The containing-vessel, together with the zinc deposit, serves as the cathode.

## V. MISCELLANEOUS TYPES

## THE MARX LIQUID BATTERY

In this battery<sup>3</sup> the energy is stored, not in the electrodes, as is customary, but in the electrolyte itself,

<sup>1</sup> G. P., 57,188; 1890.   <sup>2</sup> B. P., 7711; 1893.   <sup>3</sup> A. P., 440,175; 1890.

which is, therefore, termed *electroline*. The electrodes are ordinarily of carbon, 2 negatives to 1 positive. The electrolyte, or *electroline*, is made up as follows :

Perchloride of iron . . . . .	450 grammes.
Water . . . . .	900 grammes.
Hydrochloric acid . . . . .	500 grammes.

The passage of a current between the plates causes the liquid to assume a greenish tint. It then turns yellow, and, finally, a yellowish brown. When the cell is fully charged, which is indicated by the color of the liquid, the electrodes are removed. In order to discharge the cell, it has been found best to use electrodes of varying conductivity, such as zinc or iron, in conjunction with carbon, iron being usually employed in preference to the charging electrodes. When a highly porous carbon block is placed in the *electroline*, between the two metallic electrodes, and the outer circuit is completed, the liquid decomposes, passing through the same series of colors, but in the reverse order, that it does during the charge.

#### PLATNER <sup>1</sup>

Zinc and carbon plates are placed horizontally in a concentrated solution of pure ferricyanide of sodium. When the cell is discharged, a pulverized coating of ferrocyanide of zinc is formed on the zinc plates, and the solution is reduced to ferrocyanide of sodium. The reverse action takes place during charge.

<sup>1</sup> G. P., 81,494-82,100; 1886.

HAID<sup>1</sup>

Iron electrodes, covered with tin or lead, and having apertures for the reception of the active material, are used. The active material is formed of Prussian blue and oxide of lead, a suitable covering being placed over the electrodes in order to retain the active material.

## BASSET

In this cell<sup>2</sup> each electrode is formed of carbon, covered with peroxide of iron and wrapped in blotting-paper, and the electrolyte is a solution of protochloride of iron. The containing-vessel is lined with a mixture of wax, paraffin, and pulverized colcothar.

## TAULEIGNE

Tauleigne uses carbon in a porous cup as the negative electrode, lead chloride being packed firmly around the carbon. Carbon also surrounds the porous cup, thus serving as the positive element. The electrolyte consists of a 60% solution of protochloride of iron.

## KALISCHER

In 1885 Dr. Kalischer<sup>3</sup> brought out a cell which was intended to overcome the usual disadvantages of lead accumulators. As an anode, he used iron, and as a cathode amalgamated lead. The electrolyte was a concentrated solution of nitrate of lead. The iron resisted the corroding action of the solution. The E.M.F. of the cell was 2 volts.

<sup>1</sup> A. P., 271,628; 1883: 294,464-296,164; 1884.

<sup>2</sup> A. P., 306,051; 1884.

<sup>3</sup> A. P., 311,007-311,008; 1885.

## MALONEY

The electrodes of a cell described in a patent issued to J. F. Maloney,<sup>1</sup> in 1883, are composed of black oxide of manganese and carbon, the electrolyte containing ammoniacal salts.

HOLLINGSHEAD <sup>2</sup>

The positive plate of this cell is composed of dioxide of manganese, and the negative plate of iron or steel. The electrolyte is composed of water containing an iron salt, which, on decomposition, deposits an insoluble compound on the negative and a soluble compound on the positive plate.

## LEHMAN

Lehman<sup>3</sup> places commercial barium superoxide, in a soft paste, on his plates, the electrolyte being a solution of barium chloride, barium bromide, barium iodide, or such an acid as will produce an insoluble, or nearly insoluble, barium salt, (as nitric acid(?), sulphuric acid, or phosphoric acid).

## DARRIEUS

According to some German patents granted to Darrieus,<sup>4</sup> spongy antimony plates are used for the negative and lead peroxide, or oxidized antimony, for the positive electrodes, in a dilute, sulphuric-acid electrolyte. The advantages claimed are: that sulphate is not formed on the negative plates from local action, that the mechanical strength is greater, and that the weight is less than is the case with ordinary lead elements.

<sup>1</sup> A. P., 271,880; 1883.

<sup>2</sup> A. P., 422,126; 1890.

<sup>3</sup> G. P., 70,708-72,199; 1893.

<sup>4</sup> G. P., 81,080.

## CHAPTER VI

### THEORY OF THE STORAGE BATTERY

ALTHOUGH much has been accomplished in the direction of the practical development of the storage battery, during late years, and much valuable information has been obtained, yet, at the present day, very little as regards the precise chemical reactions which occur have been definitely settled. E. J. Wade<sup>1</sup> says: "It is probably for this very reason that storage cells are still so far from practical perfection, as compared with dynamo electric machinery, and other apparatus in whose development theory and practice have gone hand in hand." It should be remembered, however, that the chemical problems to be solved are exceedingly difficult. Dr. Frankland<sup>2</sup> called attention to this fact during the discussion of Professor Ayrton's paper on the "Chemistry of Secondary Batteries."

"The physical qualities of the cells are capable of very accurate estimation and investigation. But when you come to attempt to ascertain the chemical changes that occur in the charging and discharging of a storage cell, you encounter formidable difficulties. The outsider has no idea of these difficulties. Nothing seems more simple than to determine the chemical changes that take

<sup>1</sup> London Electrician, Vol. 33, p. 625.

<sup>2</sup> London Electrician, Vol. 26, p. 177.

place in either the positive or the negative plate of a storage battery. It is not so in reality. The substances used as active materials are in the first place mixtures, and the materials obtained at the end of the reactions are also mixtures, and these mixtures are insoluble in any reagent which does not decompose them. They cannot be volatilized; they cannot be subjected to any process of solution and crystallization in order to separate and purify their elements."

The general theory of the storage battery is almost identical with that of the primary battery. It is subject to the same general laws, and is coupled up in the same way as the ordinary voltaic cell, and when charged, it becomes simply a primary battery. It, however, possesses this immense advantage, in that when used up, its component materials can be brought back to nearly their original condition by passing a current through the cell.

The general theory of the storage battery may be briefly stated as follows: During the discharge, both electrodes are converted into lead sulphate, with the extraction of sulphur from the electrolyte, thus reducing the density of the solution. The action on the positive plate is supposed to take place in two stages: first, the reduction of the peroxide to monoxide, and then the conversion of the monoxide into sulphate. On charging, the action is reversed, the sulphate being converted into peroxide on the positive and metallic lead on the negative plate. Many investigators believe that it is hydrated peroxide of lead ( $H_2Pb_2O_6$ ), rather than lead peroxide ( $PbO_2$ ), which is formed on the positive plate.



Many manufacturers now use lead sulphate as the active material in pasting both their positive and negative plates, instead of following the older method of applying minium to the positive and litharge to the negative plates. The amount of electrical energy which can be thus stored by the conversion of the lead sulphate into peroxide, or hydrated peroxide of lead, as the case may be, is proportional to the amount of active material formed and capable of being acted upon.

“Theoretically, the amount of energy which one pound of lead would generate, if wholly converted into lead sulphate, could be produced by a quarter of a pound of zinc or iron, or about half a pound of copper. Practically, the very property of lead which at present constitutes its superiority to other metals, that is, the insolubility of its sulphate, at the same time limits its efficiency, by reducing the energy obtainable per pound of metal to a small fraction of the amount theoretically possible. In the first place, the active material requires a grid or support of inactive material, which, even in the best form, will weigh nearly as much as itself, and in the Planté type may be many times its own weight. Secondly, under the best conditions, not more than one-half of the active material is really acted upon, because the sulphate formed on its surface effectually screens the inner portions. The combined effect of these two causes is that not more than 5% to 15% of the weight of the electrodes is usefully employed.”<sup>1</sup>

The theoretical value of lead peroxide has been estimated by Planté to be 4.48 grammes for one ampere-

<sup>1</sup> London Electrician, Vol. 33, p. 605.

hour. A later investigator gives the value as 4.44 grammes per ampere-hour. The former value is probably the correct one, as the majority of investigators have obtained that result. This gives approximately 100 ampere-hours per pound of active material. Assuming that the positive and negative plates are identical, the result would be 50 ampere-hours per pound of peroxide and spongy lead. Plates of the highest capacity do not, however, yield more than 16 ampere-hours per pound of peroxide and spongy lead. This difference is due to the fact that all the active material cannot be used, and that support plates of nearly equal weight must be employed. Faure has calculated that with a total thickness of 5 mm., the action penetrates to a depth of  $\frac{1}{2}$  mm., thus making 80% of the weight dead weight. With a greater porosity, of course, the percentage of dead weight would be much smaller.

Dr. Streintz<sup>1</sup> believes that the chemical energy in an accumulator is due to the sulphating, neglecting the secondary reactions, such as the absorption of hydrogen at the negative plate, the generation of free gases, and the formation of hydrated lead oxide. This theory assumes as its foundation that metallic oxides cannot exist in the presence of free acid. Dr. Darrieus<sup>2</sup> has, however, come to the conclusion that the oxides can so exist. It has been found that when an acid acts on an insoluble oxide, the product itself being insoluble, the action is never complete. He believes that the sulphate which is to be found on the positive plate after discharge is always variable in quantity, and is due

<sup>1</sup> Wied. Ann., Vol. 53, p. 698.

<sup>2</sup> L'Electricien, May 18, 1895.

only to the local action of the acid on the oxide, and that it is never included in the principal reactions of the discharge.

If the chemical reactions occurring during the charge and discharge of a cell were exactly the reverse of each other, then the E.M.F. of charge and discharge would be the same. Professor Ayrton<sup>1</sup> has found that the E.M.F. for about two-thirds of the charge is very nearly 0.14 volts higher than that during the corresponding

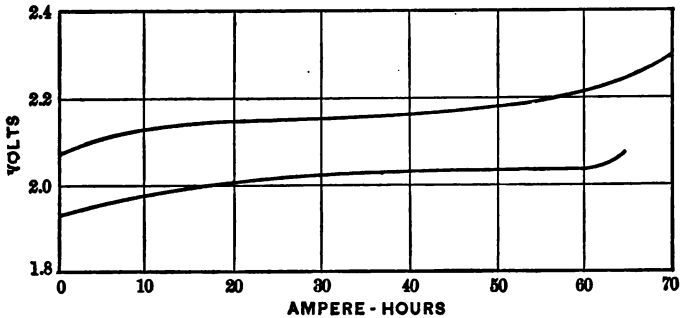

FIG. 77.

periods of discharge, and that from this point onwards the difference continually increases. Even after full allowance has been made for the internal resistance of a battery, the E.M.F. of charge is always higher than that of discharge. Fig. 77, which is taken from Professor Ayrton's paper, illustrates this; curve *a* shows the variation of E.M.F. during the charge, and curve *b* that during the discharge. Curve *b* is expressed in relation to the ampere-hours contained in the cell, the point at which the discharge is stopped being assumed to cor-

<sup>1</sup> Jour. Inst. Elec. Eng., England, Vol. 19, p. 699.

respond to emptiness. It is, in reality, therefore, the ordinary curve of discharge plotted backwards. These curves were taken from an E.P.S. cell. The persulphuric acid which is the primary product at the positive electrode during the charge is, according to Wade, the cause of the high E.M.F. It is now generally believed that there is no possibility of doing away with the waste reaction in the formation of persulphuric acid.

It is interesting to note here that Dr. Streintz<sup>1</sup> has found that the internal resistance of a battery is a function of the current. For small currents it is higher than when on open circuit; while for strong currents it falls, and becomes less than when on open circuit. The internal resistance of the accumulator when on open circuit increases with the number of discharges. According to Schoop, the internal resistance is the smallest when the cell is about half discharged, after which it increases, sometimes reaching as high as 15 times its minimum value. In Fig. 78 are given curves showing the specific resistance of the acid of a storage cell at different strengths and temperatures. It will be seen from these curves, that while an acid, the strength of which corresponds to the specific gravity 1.250, has the least resistance, it does not give the highest voltage. The use of such acid possesses the disadvantage that during the discharge the specific gravity diminishes, and consequently the resistance of the cell increases and the voltage falls.

The largest change that takes place in the electrolyte is, naturally, an alteration in the degree of concentra-

<sup>1</sup> Zeit. für Elektrotechnik, Nov. 1, 1893.

tion. "The proper proportion between the active hydrogen and that which appears electrolytically seems to bear some relation to the capacity of the plate. It does not, as Gladstone and Tribe suppose, vary inversely with the current strength, but it is highly probable that, for every plate, there exists a current density for which this proportion becomes a maximum."<sup>1</sup>

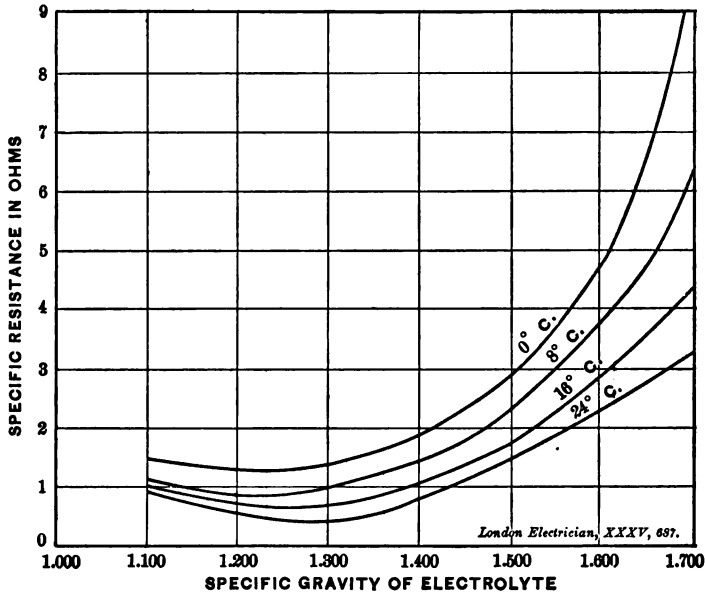

FIG. 78.

According to Duncan and Weigand,<sup>2</sup> the principal defects of the modern lead-sulphuric-acid storage battery are :

- I. Loss of energy.
- II. Depreciation.

<sup>1</sup> London Electrician, Sept. 4, 1891. <sup>2</sup> Trans. A. I. E. E., Vol. 6, p. 217.

III. Comparatively small storage capacity per unit of weight.

IV. The low discharge rate necessitated by considerations of efficiency and depreciation. The discharge rate has, however, been so much increased in the later

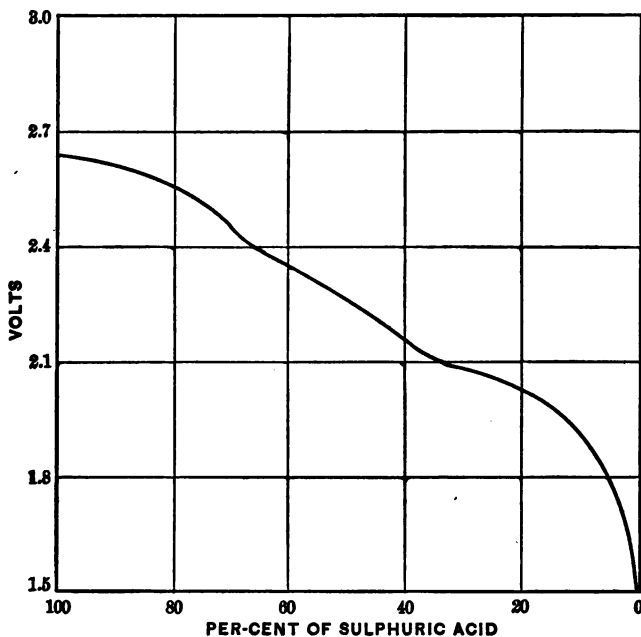

FIG. 79.

forms of batteries, especially in those of the Planté type, that the last objection has practically been done away with.

The loss of energy manifests itself in two ways :

1. In the generation of heat.

2. In chemical reactions which are reversed during discharge.

It is well known that the voltage of a cell varies directly with the degree of concentration of the electrolyte. Gladstone and Tribe have found that when the acid is very weak, the chemical action is changed, the result on the positive plate being the formation of a

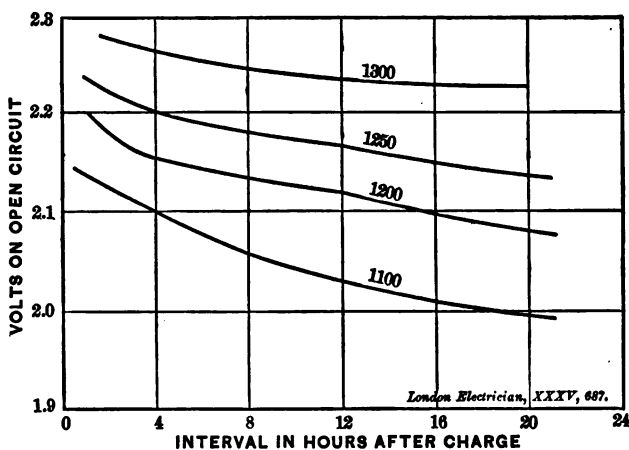

FIG. 80.

mixture of yellow and puce-colored lead oxides, while on the other parts a white substance which is easily detachable is deposited. Messrs. Gladstone and Hibbert have further proved conclusively that the E.M.F. of a cell does depend, in some way, upon the strength of the acid employed. Fig. 79 shows the result of their observations. In Fig. 80 a set of curves is given, showing the fall of the open-circuit voltage for 21 hours after the completion of the charge, and the influence of different strengths of acid.

In a communication to the American Institute of Electrical Engineers, in May, 1894, Mr. Griscom states that the potential of a cell is partly due to the degree of charge of the positive, partly to that of the negative plate, and partly to that of the electrolyte. If a negative plate be taken from a fully charged cell, which indicates, for example, 2.65 volts with the normal charging current, and be coupled with the positive from a partly discharged cell, indicating 1.9 volts at the normal rate of discharge, it will be found that the resulting E.M.F. lies between the two. If the couple be removed to other electrolytes, it will be found that the E.M.F. will rise or fall according to the greater or less density of the new solution as compared with the old. From this it will be seen that the measurement of the potential difference at the terminals of a cell is not a sure indication of the charge, unless both plates are equally charged, and this is a condition which rarely obtains in practice. It will be found, however, that the variations of the specific gravity of the liquid are approximately proportional to the useful capacity of the cell, if we take account of the local action, the short-circuiting, the changes in temperature, and the general sulphating of the positive plates while idle.

The examinations of the characteristic curves of a cell show very plainly the variations of the E.M.F. It is found, for example, that, in a storage battery whose plates are of nearly equal capacity, the changes in the positive plate determine the characteristic curves of potential on discharge, and the changes in the negative those at the end of the charge.



Although, according to the majority of laboratory tests, an accumulator possesses an energy efficiency of from 80% to 85%, yet, in commercial practice, an efficiency of more than 70% is seldom realized. Besides the regular transmission loss, about 15%, there is a loss due to leakage, to local action, to the cells not being in the best condition, and to several other causes which do not occur in the laboratory tests.

Crosby and Bell divide the losses incurred into four groups:

1. The direct losses due to heating.
2. The losses due to local action between the supporting grid and the active material.
3. The losses due to local action in the active material itself.
4. The losses due to the unreversed chemical action.

It is the last two sources of loss which are generally the most formidable. Of the losses due to irreversible chemical actions, a portion is ascribable to the production of irreversible chemical compounds, and a portion to the electrolytic action producing free hydrogen, oxygen, ozone, and hydrogen peroxide. It has been found that thick grids, with heavy plugs of active material of corresponding thickness, are the most likely to suffer from the various losses, except the first, because the chemical action in a large and dense mass of material is by no means uniform throughout, and consequently differences of potential probably occur between different portions of the same plug.

The amount and character of the by-products formed is very largely determined by the rate of discharge and

the working temperature of the cell. During the discharge of a cell, as has been stated, free oxygen, hydrogen, ozone, and hydrogen peroxide are formed in the solution, and attack the plate, without materially assisting in the discharge. Other and more complicated substances are also produced, — basic sulphates and the like.

Darrieus<sup>1</sup> has found that an antimony-lead grid and lead peroxide will give 1.4 volts, and that the potential difference between an antimony-lead grid and spongy lead in dilute sulphuric acid is 0.52 volt.

It is a matter of common experience that if an accumulator be discharged slightly, before being allowed to rest for any considerable length of time, the local action will be increased. In order to avoid local action, contact between the conducting grid and the electrolyte must be avoided. This is accomplished by having an unbroken layer of peroxide on the surface. A slight discharge breaks or destroys this layer; hence the increase in local action. If the materials used in the plates be pure, the electrolyte also pure and of the proper strength, and if the conditions favorable to the formation of persulphuric acid be avoided, local action will be found to be greatly reduced. According to a test by Epstein,<sup>2</sup> the average loss of charge of several accumulators tested was only about 20% during a period of three months; and Sir David Salomons<sup>3</sup> has found that of some discharged plates, which had been left idle for four years, the only fault was a bad color. In all other

<sup>1</sup> L'Electricien, Nov. 17, 1894.    <sup>2</sup> London Elec. Rev., Feb. 1, 1895.

<sup>3</sup> London Electrician, Dec. 15, 1893.

respects they were as good as ever. "He feels assured that, if the discharge has not been too rapid, no harm would be done by allowing them to stand for years. The plates are, however, certain to buckle if they are not charged in the usual way. A sure method to prevent this is to brush the positives with a stiff brush, in order to remove the surface scale, after which they may be charged, but slowly at first." Gaston Roux<sup>1</sup> has also found that if an accumulator of the pasted type be charged to saturation, and then left on open circuit, that the local action will be very slight, and the cell will lose, at a maximum, not more than 6% of its capacity in three months.

Many investigators, including Messrs. Gladstone and Tribe, were of the opinion that the local action between the active material and the support plate in the positive electrode led to the disintegration of the latter. If this theory were correct, it would be advantageous to leave the film of sulphate which covers the grid intact; and a battery should never be overcharged, as this would tend to decrease the film in question. Later investigators have, however, found that the film of peroxide which is formed on charging from the lead sulphate is the real protective coating. According to this view, overcharging is, to a certain extent, beneficial, as it tends to increase this coating, besides bringing all the active material into the condition of lead peroxide.

One of the most interesting phenomena in the discharge of a cell is the passing of current from one plate to another. It has been found that, with plates

<sup>1</sup> London Electrician, Vol. 25, p. 754.

manufactured rigorously alike, kept in parallel, and subjected to the same treatment, the current variations often amount to more than 30%. It has also been found that the E.M.F. of different plates of a cell, connected in parallel and discharged through equal resistances, will vary from 1.6 to 1.85 volts. This gives rise to a rather peculiar phenomenon, that of the exchange of charge. It had been previously held that if one plate had less capacity than another, that at a certain point it would cease to discharge; but that its E.M.F. would be the same as the rest, and consequently there would be no flow of current. Mr. Griscom has, however, found that, on breaking the circuit at the end of the discharge, it was hours before the batteries reached equilibrium, owing to the considerable flow of current which passed. He explains this by saying that "the deficient plate keeps on discharging at a lower rate than the perfect plate, and finally reaches a much lower point of discharge. On interrupting the current, the plate which has not been discharged so completely rapidly recovers a higher voltage than the other, and therefore discharges into it. This effect will also take place in different parts of the same plate, and may be a cause for the formation of peroxide on the surface of a negative plate after discharge."<sup>1</sup>

Mr. Griscom also found that, when left at rest, the positive plates in a section will discharge themselves. Sir David Salomons, in a communication to the American Institute of Electrical Engineers, in May, 1894, stated that "there are probably two causes for this:

<sup>1</sup> Trans. A. I. E. E., Vol. 11, p. 302.

first, the slight leakage which exists in every installation; and secondly, a leakage in the cell itself, apart from any local action which may take place in consequence of the material employed in building up a section." Many users of the storage battery have found that the addition of caustic soda, or of sulphate of soda, greatly reduces the slow automatic discharge.

Indirect evidence as to the nature of the chemical changes taking place in an accumulator may be derived from an examination of the curves representing the variations in the temperature of a cell during charge and discharge. In both cases, if all the reactions were absolutely electrolytic, no heat would be generated, except that due to the internal resistance of the cell. Any rise in the temperature, therefore, except that which may be accounted for in this manner, must be ascribed to wasteful, "unelectrolytic, heat-producing action," including local action. Curve *a*, Fig. 81, shows the rise in temperature during the charge, and curve *b* the fall during discharge. Upon calculating the amount of heat liberated, to which the fall in temperature corresponded, it was found to far exceed the internal resistance of the cell, and in fact it was equivalent to 17% of the total amount of energy put into the cell while charging. Professor Ayrton has found that the working temperature of a cell is always above that of the air, even when its temperature is falling in discharge. In Fig. 82, taken from the same article, will be found curves representing the rise in temperature, in degrees per ampere-hour. Curve *a* represents the rise during charge, and curve *b* that during discharge.

As before stated, Duncan and Weigand<sup>1</sup> found that the loss of energy exhibits itself in two ways, one of which is a generation of heat. This rise in temperature they found to be due to:

1. The Joule effect.
2. The current set up by local action between the active material and the support plate.

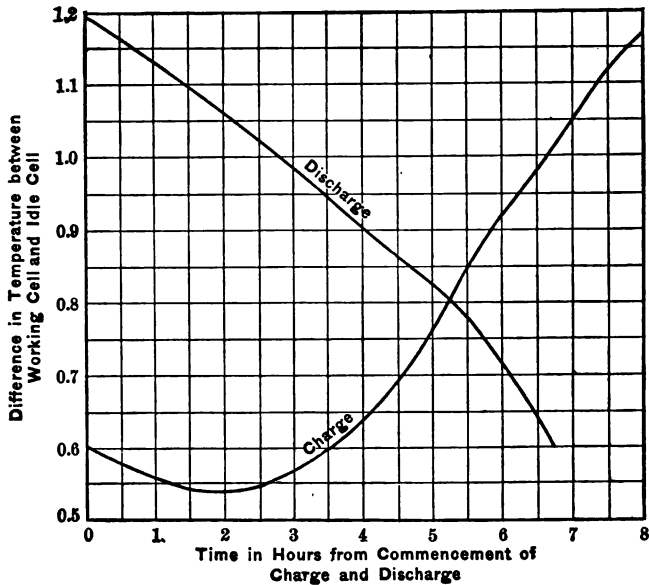

FIG. 81.

3. The current set up by local action in the plugs.
4. The heat losses corresponding to the electrolysis of the solution.

It has been generally held that the temperature of a cell varies with the internal resistance, and therefore

<sup>1</sup> *Vide* page 116.

that the chemical or cooling effect will at times predominate, and at others the  $I^2R$ , or heating effects; and that for every cell there exists a point where the two factors will balance each other, and beyond which heating or cooling will ensue. The experiments of Ayrton, Griscom, and Reckenzaun prove that this so-called law very seldom holds. In one case, according to Reckenzaun, the temperature of the cell was at least  $4^\circ$  below

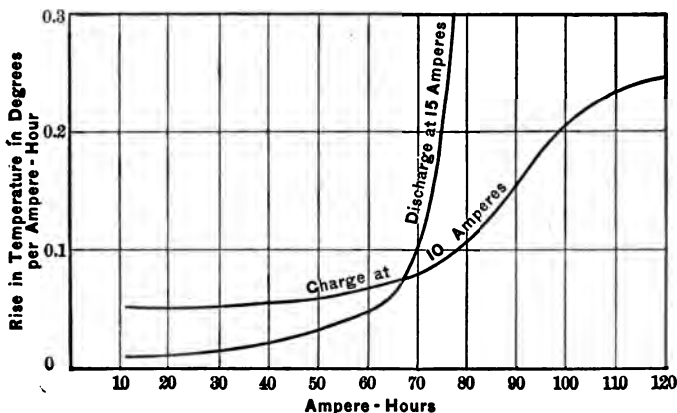
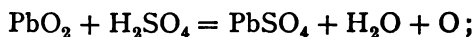

FIG. 82.

that of the normal, while the internal resistance was at least double that of the average. Besides this, the heating effects cannot vary as the square of the current since the internal resistance diminishes as the current increases, and what is still more remarkable, the E.M.F. itself seems to rise.

The average variation in capacity in a cell whose temperature ranges from  $0^\circ$  to  $22^\circ$  C. is about one-half of 1% for each degree change in temperature.

Since the tendency of the acid in the electrolyte is to form sulphate of lead, from both the spongy lead on the negative and the peroxide on the positive plate, the generally accepted theory at present is that of the direct formation of lead sulphate at both electrodes. Each molecule of the peroxide is supposed to lose an atom of oxygen, and each atom of spongy lead to gain an atom of oxygen. Two atoms, or molecules, of hydrogen sulphate are thus abstracted from the electrolyte to react with the peroxide or spongy lead, and their place is taken by two atoms of water. The reaction for the positive plate, according to this theory, is, therefore,



and that for the negative plate is

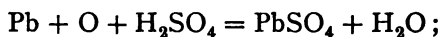

or, including both reactions in one equation,

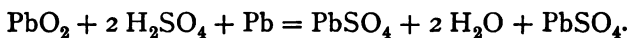

Thus the final result of the complete discharge of a cell is to form lead sulphate and water by removing sulphuric acid from the electrolyte and depositing sulphate of lead upon each plate.

The above is, fortunately, a self-limiting process, since the sulphate is a poor conductor. All the peroxide is therefore not acted upon, and at the end of the discharge we have peroxide of lead crystals covered with a coating of sulphate. It has been estimated that not more than 50% of the peroxide is converted into sulphate.



In Professor Ayrton's paper on the "Chemistry of Secondary Cells," to which reference has already been made, the following important conclusions were drawn by his assistant, Professor Robertson:

1. The particles of the peroxide soon get coated in the discharge with a layer of lead sulphate, which protects the peroxide from further action.

2. The analysis also shows that a proportion of active material still remains at the end of the discharge.

3. The loose, powdery surface of the peroxide plate seems to be thoroughly converted into lead sulphate.

4. When the peroxide on the surface of the plate falls to about 31%, the cell very rapidly loses its E.M.F., owing to the inactive layer of sulphate, which impedes the action of the sulphuric acid on the active material beneath; and also to the formation of peroxide on the negatives. The diffusivity of the acid is decreasing, and it has to penetrate further and further into the plate to find the active material. When the whole of the paste approaches the composition of 31%, the cell loses its E.M.F. entirely.

5. The action seems to take place most rapidly where the current density is the greatest; the plate becoming hard there from sulphate soonest during discharge, and oxidizing there the quickest during charge.

Planté, and Gladstone and Tribe, have noticed the formation of lead peroxide on the negative electrode during the discharge of a battery, and have pointed out that when it commences to form more rapidly than it is reduced, the two electrodes will rapidly approach equilibrium. Since when the circuit is broken local

action alone can take place, the peroxide on the negative plates will be reduced, and on making the circuit again the cell will once more give a current. In this way Messrs. Gladstone and Tribe account for the re-suscitating power of the storage battery, as well as for the rise of E.M.F. on breaking the circuit.

If the positive plate of a lead secondary battery be examined microscopically, there will be found soft, porous crystals of a very dark color, which are probably electrolytic peroxide. There will also be found some brilliant red crystals, probably Frankland's red sulphate; also the yellow sulphate crystals, and finally the well-known white sulphate. The negative plate will show metallic lead, with one and sometimes two sulphates. The production of the diverse chemical products is probably attended by the production of different potentials, and the final E.M.F. of the battery must therefore be a resultant with one or more chemical reactions predominating at various parts of the discharge.

In Mr. W. W. Griscom's paper on "Some Storage Battery Phenomena," read before the American Institute of Electrical Engineers in May, 1894, several very interesting curves of charge and discharge for both positive and negative plates were shown. An examination of the curves for the negative plate of a Faure cell showed at the end less capacity than that for the positive plate. Within the working limits of charge or discharge the negative plate did not vary over 2% of potential difference. The positive plate showed a fluctuation of about 6%. The total fluctuation of the

cell after the first few minutes was 6% in discharge down to 1.9 volts.

When a cell is supposed to be fully discharged, it is often noticed that at least 30% of peroxide is still to be found in the positive plate. From this it has been inferred that the negative plate has 30% less capacity than the positive. In one sense this is true; but, more strictly speaking, it is probable that the negatives have the same capacity as the positives, but discharge 30% sooner.

It is a well-known fact that a high rate of discharge is injurious to a battery. Messrs. Duncan and Weigand have found that when the rate of discharge is too rapid, acid is taken from the solution inside the plug, thus weakening the solution, which only gains acid by diffusion from the outside. This diffusion increases greatly as the capacity is lowered, the acid in the plug becoming very weak, and a phenomenon which was noticed by Gladstone and Tribe occurring. They found that at a certain dilution the chemical action changes, and a new compound is formed in place of the peroxide of lead; also that the plate becomes greatly corroded.

In Figs. 83 and 84 will be found curves showing the capacities per pound of active material for different specific gravities at the end of the discharge, and corresponding curves for the voltage. These were taken from two Chloride cells, one having thin and the other thick plates, the rate of discharge for each being 0.45 ampere per pound of plate. The rate per pound of active material was approximately the same for both, but the rate per unit of area was nearly 40% greater

for the thick plates. It will be found from an examination of the curves, that the capacity practically varies inversely as the thickness. Curve *a* was taken from plates 0.24 inch thick, and curve *b* from plates 0.4 inch thick.

After a certain portion of the active material in a plate has been converted into lead sulphate, further sulphation is attended with a production of normal

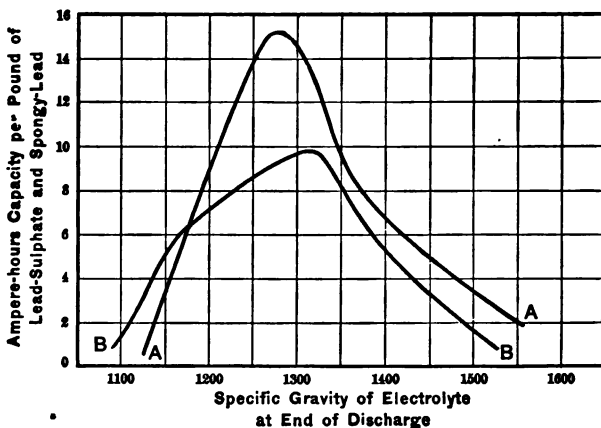

FIG. 83.

white sulphate. At this stage in the discharge, the diffusion of the persulphuric acid which remains over from the last charge, and its decomposition with the formation of hydrogen peroxide, leads to the production of peroxide of lead on the negative plate. The formation of such a compound on discharge explains the rapid fall of E.M.F. to be noticed at the close of the discharging period.

When the discharge is very rapid, sulphation will

take place rapidly, and the sulphuric acid which is distributed through the mass of the active material will be, to a large extent, withdrawn before it can be replaced by diffusion. It is evident that in such a case the E.M.F. will fall, and that as soon as diffusion can take place, a higher E.M.F. will follow. We are able to explain thus the higher voltage of a cell after a period of rest.

Before charging accumulators, the positive and negative plates which have been formed, either by the Planté

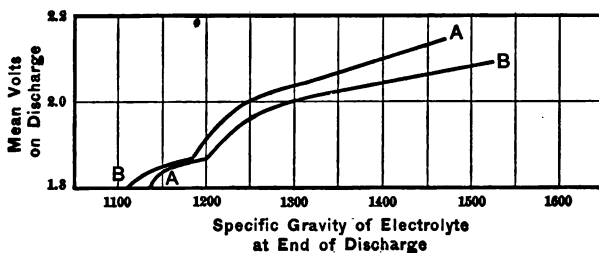

FIG. 84.

or Faure process, contain a sulphated salt of lead, usually termed lead sulphate ( $\text{PbSO}_4$ ). During the charge the lead sulphate is changed into peroxide of lead ( $\text{PbO}_2$ ) on the positive plate, and spongy lead ( $\text{Pb}$ ) is formed on the negative plate. The liberated sulphion ( $\text{SO}_4$ ), combining with the  $\text{H}_2$  of the water, increases the density of the electrolyte, and the liberated oxygen combines to form  $\text{PbO}_2$ . Sir David Salomons<sup>1</sup> has divided the process into three stages, and considers it as follows: "The first stage indicates the discharged cell. The second indicates what might be termed the

<sup>1</sup> Elec. Light Installations, 7th edit., Vol. 1, p. 100.

rational change which takes place, though in all probability a number of equations would be necessary to represent what really happens between the first and last stages. In this stage molecules of water have been taken from the electrolyte, and an equal number of molecules of sulphuric acid added, thus increasing the strength of the acid solution. In the third stage—the charged cell—the specific gravity of the electrolyte may decrease slightly.”

	Positive.	Electrolyte.	Negative.
1st stage	PbSO <sub>4</sub>	H <sub>2</sub> SO <sub>4</sub> + H <sub>2</sub> O	PbSO <sub>4</sub>
2d stage	PbO	H <sub>2</sub> SO <sub>4</sub> + H <sub>2</sub> O	PbO
3d stage	PbO <sub>2</sub>	H <sub>2</sub> SO <sub>4</sub> + H <sub>2</sub> O	Pb

Besides this, an additional chemical action takes place during the charging, gas being given off at the negative, and when charging is nearly finished, at both electrodes.

Gladstone and Tribe,<sup>1</sup> who have investigated the subject, say: “The principal, if not the only, function of the hydrogen of the water is that of reducing the lead compounds.” Messrs. Streintz and Neuman, arguing from this fact, claimed that the occlusion of the hydrogen was the chief factor in the charge of an accumulator. Strecker has proven, however, that the charge is based chiefly on the reduction of the sulphate of lead, rather than on the occlusion of hydrogen.

According to the occlusion theory, the oxygen and hydrogen, dissociated during the charging, are occluded at the electrodes, the hydrogen at the negative and the oxygen at the positive pole; and these gases on recombining give the phenomena of discharge. This theory

<sup>1</sup> Chemistry of Secondary Batteries, p. 48.

was strengthened by the fact that the activity of the Grove gas battery was known to be due to the recombination of the gases which covered the electrodes. According to this theory, the presence of sulphuric acid in the electrolyte is merely to give conductivity to the water.

When dilute sulphuric acid is electrolyzed with platinum electrodes, the dissociation of hydrogen and oxygen is accompanied by the absorption of energy; which energy, less that lost in overcoming the resistance, is yielded upon the recombination of these gases. The same E.M.F. which is needed to overcome the affinity of the oxygen for the hydrogen will be developed when these gases recombine. An E.M.F. of approximately 1.5 volts is needed for electrolyzing dilute sulphuric acid. This result could be anticipated from the fact that 34,180 c.g. calories are liberated when oxygen and hydrogen combine to form water. According to the method given by Lord Kelvin for calculating the "volta-motive-force" from chemical union, this energy corresponds to 1.492 volts. Since the normal E.M.F. of a lead-sulphuric-acid accumulator is very nearly 2 volts, something more than the tension produced by the occlusion of hydrogen and oxygen is necessary to explain the E.M.F. of secondary cells. Of the hydrogen liberated during charging, only traces are found at the negative electrode. Dr. Frankland has also proven that neither oxygen nor hydrogen is occluded during charging.

Although Planté, Dr. Oliver Lodge, and other firm believers in the occlusion theory had noticed the for-

mation of lead sulphate throughout the active material, and on the grid itself, they ascribed it to local action. Dr. Lodge believed that, to obtain the best results, the amount of acid in the electrolyte should be small. Many investigators, even at the present day, hold that water plays the most important part in the primary reactions of electrolysis.

It is now generally assumed that the acid breaks up under the action of the current into hydrogen ( $H_2$ ) at the negative and sulphion ( $SO_4$ ) at the positive electrode. According to the modern views of electrolysis, some portion of the hydrogen sulphate in the solution already exists in a dissociated form as free molecules of  $H_2$  and  $SO_4$ . As soon as a difference of potential is set up between them, these molecules are attracted to either electrode, and their place is immediately taken by others. If this assumption be correct, it is easily seen that the water merely serves as a solvent, and as a medium in which dissociation can take place, rather than playing a direct part in the process. In 1878 Berthelot discovered persulphuric acid [ $H_2(SO_4)_2$ ], and showed that it was the primary product at the positive electrode when dilute sulphuric acid was subjected to electrolysis. Later Messrs. Robertson and Darrieus, working independently of each other, obtained the same result. Their experiments were conducted with ordinary lead cells in actual use, and under normal conditions. According to the theory advanced after these discoveries, the freed sulphion, which cannot exist in a free state, nor, in the case under consideration, enter into combination with the substances on the positive



electrode, combines with the sulphuric acid, rather than with the water; thus:

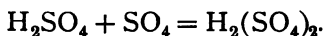

It is this reaction which is the cause of the high E.M.F. which is required to produce decomposition. "For persulphuric acid is one of those comparatively rare compounds, termed exothermic, whose formation is accompanied by an absorption of energy, and which liberate energy in decomposition. This acid is very unstable, and almost immediately decomposes at the electrode, reacting with the water, and passing back to normal sulphuric acid, with the formation of hydrogen peroxide, and then of water and liberated oxygen"; thus:

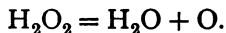
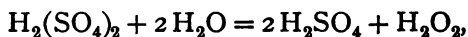

At the end of the discharge the positive plate consists of small particles of lead peroxide, covered with lead sulphate, the free sulphion combining with the lead sulphate, forming persulphate of lead  $[\text{Pb}(\text{SO}_4)_2]$ :

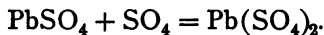

This reacts with the water, forming lead peroxide, and normal hydrogen sulphate:

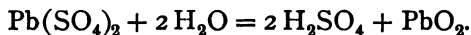

At the commencement of the charge, when there is a large quantity of lead sulphate present, it is probable that a very large percentage of the sulphion is absorbed in this manner, and that only a small part reacts with the hydrogen sulphate, forming hydrogen persulphate.

After a certain point in the charging has been passed, the latter reaction will increase, because less and less of the sulphate remains to be acted upon by the sulphion, most of the sulphate having been converted into lead peroxide. When the plate has been thoroughly peroxidized, and cannot be further attacked, it is probable that the whole of the sulphion goes to form persulphuric acid, with immediate redecomposition and the liberation of oxygen. From this it would appear that the difference between the curves of charge and discharge, in Fig. 62, is in reality a measure of the amount of persulphuric acid formed. Unfortunately, no data are available that would enable it to be stated in absolute figures.

On the negative plate, nascent hydrogen is liberated, and exerts a powerful influence on the salts of lead that are present, reducing them to the metallic state with the liberation of hydrogen sulphate:

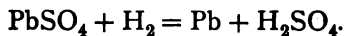

When the reduction of lead sulphate is nearing completion, the surplus hydrogen commences to pass off in a gaseous state, thus indicating the end of the charge.

From these facts it would appear that there is no advantage to be gained by continuing the charging after the hydrogen or oxygen has ceased to be absorbed freely, because the presence of some unoxidized sulphate, although it increases the internal resistance, rather impedes than promotes local action. On the other hand, it is absolutely necessary that the minimum on the opposing plate should be thoroughly reduced,

because a mixture of peroxide and metallic lead is very conducive to the production of lead sulphate, thus increasing the resistance and diminishing the E.M.F.

Griscom and Fitzgerald do not, however, believe that lead peroxide is present on the positive plate, but rather that the active material consists of hydrated peroxide of lead. In support of this theory, Griscom<sup>1</sup> says:

“The material on the charged positive plate is commonly called peroxide of lead, but it certainly differs from it in its ability to generate E.M.F., and in its appearance; and Fitzgerald has pointed out that its composition corresponds to the hydrated peroxide of lead ( $H_2Pb_2O_5$ ). He further intimates that a higher oxide, such as perplumbic acid ( $H_2Pb_2O_7$ ), may be present. The fact observed by Gladstone and Tribe that 34% more of oxygen was absorbed by the positive plate than could be accounted for by the production of peroxide of lead, becomes, by this means, explicable. This large percentage of oxygen has probably been used in converting the hydrated peroxide of lead into perplumbic acid. Their suggestion that it has probably been absorbed by local action between the grid and peroxide is utterly untenable. There is no such action, and if there were, the grid would not last through a dozen charges. The conversion of  $H_2Pb_2O_5$  into  $H_2Pb_2O_7$  would account for the abnormal rise of E.M.F. at the end of the charge, and if it be assumed that the  $H_2Pb_2O_7$  is unstable, yielding ozone gradually, thus accounting for the odor of a freshly charged posi-

<sup>1</sup> Trans. A. I. E. E., Vol. 11, p. 302.

tive plate, it would account for the steady fall of E.M.F. on interrupting the charging current."

As shown above, persulphuric acid diffuses through the electrolyte, and undergoes decomposition, with the production of heat, into hydrogen peroxide and normal hydrogen sulphate; the hydrogen peroxide being afterwards decomposed into oxygen and water. That persulphuric acid is formed during the charge, is indicated both by analysis and by the temperature changes occurring during that period. For the first two-thirds of the period of charging, the temperature is constant, but after that it steadily increases. This is exactly what would be expected; for, during the first two-thirds of the charging period, the amount of persulphuric acid in the electrolyte is nearly constant, but during the last third of the charge, the amount continually increases, until a point is finally reached where the persulphuric acid is decomposed as fast as it is formed.

Although the persulphuric acid theory, which is practically the same as that advanced by Darrieus, is the generally accepted one at the present day, Messrs. Elbs and Schönherr,<sup>1</sup> who have investigated the subject, oppose it. With a specific gravity of 1.300, and a current density of 2800 amperes per square metre, they found that the yield of persulphuric acid was only 24% of the theoretical yield, while with a current density of 1300 amperes per square metre, the amount could only just be detected. They claim that since the current densities in accumulators are much smaller than this, the amount of persulphuric acid formed would

<sup>1</sup> Zeitschrift für Elektrotechnik und Elektrochemie, 1895, pp. 417 and 468.

be so small as to have no effect in the production of the peroxide. According to their experiments, lead and lead sulphate are not converted into peroxide by solutions of sulphuric and persulphuric acids, no matter what the concentration. They find that a clean lead plate in such a solution is rapidly sulphated, without the formation of peroxide, and that a peroxide plate, in the same solution, is converted into sulphate with the evolution of oxygen. They admit that persulphuric acid is sometimes formed in accumulators, but they claim that its formation is accidental, and that it is only a secondary product.

Although these results are important, they seem to have but little bearing upon the theory of Darrius. It must be remembered that the experiments of Darrius and Robertson<sup>1</sup> were made with lead accumulators in actual use, and under normal conditions, while those of Elbs and Schönherr were with platinum electrodes. That there are only traces of persulphuric acid in accumulators is no proof that it is not a primary product, since but little is actually known of the products formed in lead accumulators. There is no method known by which the potential difference of the electrodes in an accumulator, as compared with an auxiliary electrode, may be measured while the current is passing, unless we except the cadmium plate test of Appleton. Further, in order to disprove Darrius' theory, it would be necessary to show, by repeated experiments, that his results were wrong. Since no proof has yet been given, it is probable that Darrius' theory will remain as the generally accepted one for some time to come.

<sup>1</sup> *Vide* page 134.

## CHAPTER VII

### APPLICATIONS,—STORAGE BATTERY INSTALLATIONS

STORAGE batteries are beyond question, to-day, a commercial part of the central station lighting business, and an important factor in the regulation at the power station. As remarked by Mr. A. E. Childs at a meeting of the American Institute of Electrical Engineers in 1895, "The great variations and fluctuations of the load on power circuits, especially those power circuits supplying trolley lines, are among the greatest difficulties which engineers have to contend against, and any appliances that will aid them to arrive at a satisfactory running of their station is looked upon with favor by them." Some engineers advocate the use of gas-engines, and others the use of two classes of machinery,—one, the most expensive and of a type giving the highest efficiency obtainable, and the other, consisting of much cheaper and comparatively inefficient, although perfectly reliable, machines. A constantly increasing number of engineers, however, believe that in the use of storage batteries lies the true solution of this problem.

As an example of how important a part accumulators are playing in central station development, it may be stated that of 189 new lighting installations in

Switzerland, 87 contain storage batteries. On March 1, 1897, of 265 central stations in actual operation in Germany, 77% employ continuous currents, and 80% of these use accumulators, whose total output is 31% of the total power of the direct generators of these stations. The total power represented by the continuous stations is 59,160 kw., while that represented by the ordinary alternating current and three-phase stations is 19,087 kw. Of the 36 central stations belonging to the Association of Representatives of German Electric Supply Undertakings, representing Norway and Sweden, Denmark, Germany, and Austria, 25 use accumulators, ranging in power from 65 to 1746 kw. hr. The ratio of the generator output to the output of the accumulators is as 124:119.

As shown in a previous chapter, the uses of storage batteries may be classed under four great heads:

1. To carry the peak of the load at maximum hours.
2. To carry the entire load at minimum hours.
3. To act as an equalizer or reservoir.
4. For the equipment of annex stations.

These four principal heads include all or nearly all the uses for which a storage battery may be employed.

1. *To carry the peak of the load.* — In all systems of lighting, whether it be gas or electricity, there is a large percentage of the connected load, which is used for only a short period of the 24 hours. This period of maximum demand, it has been found, varies from 1.5 to 4 hours per day. It is to take care of this load that gas-engines and inexpensive machinery have been proposed. The Boston Edison station have given both

inexpensive machinery and storage batteries a thorough test, and have found that the batteries give by far the best results; so much so that in 1897 they placed an order for a fourth plant. In the Boston station, 90% of the total output is produced by means of multipolar generators driven by vertical triple expansion engines; and yet the total capacity of this apparatus is not 50% of the maximum load of the station during the winter. If a steam plant be installed to take care of this 50% of the maximum load, which is but 10% of the entire output, measured in kilowatt-hours, it is evident that the station will find itself running with an extremely small load factor, and consequently with very low efficiency.

2. *To carry the entire load at minimum hours.* — If a station have a very small "motor load factor," as is the case in many of the European stations, then it would pay, perhaps, to shut down during this period, thus saving one shift of men, and making a reduction in the boiler room expenses, from drawing the fires. In the majority of American stations, however, the period of minimum load is so short, — in the Boston station being only 6 hours, — that it is found to be more economical to charge the battery during this period of light load, than to draw the fires and to throw the work of the station upon the batteries.

In a communication to the American Street Railway Association, Mr. McCullough gave a theoretical curve, (shown in Fig. 85), which illustrates these two preceding conditions. In this, the period of light load is found to be 5 hours, from midnight to 5 A.M., while



during the remainder of the day, 5 A.M. to midnight, the steam plant is operating at full capacity.

3. *To act as an equalizer or reservoir.* — It is this use of the storage battery which will especially appeal to engineers, whether they be connected with lighting or power stations. In modern stations electricity is delivered both to the “bus-bars” in the central station,

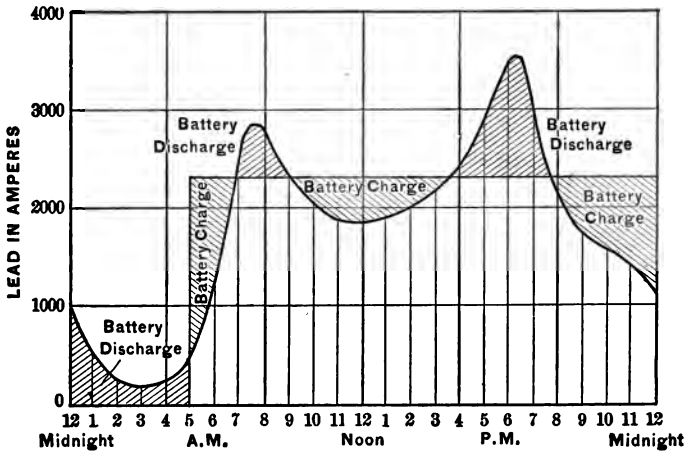

FIG. 85.

and to “bus-bars” in the annex stations, thus being delivered at varying potentials. During the period of light load, the drop will be scarcely noticeable, and the pressure at the lamps practically constant. As the load increases, extra dynamos are thrown in, until the maximum load is reached. Where a station is not equipped with batteries, it is almost an hourly question as to what it will be necessary to do next; whether to start dynamos or to stop them, or to change “boosters.” This

trouble is intensified by the uncertainty as to what the load is going to be at any given time.

When, because of a sudden storm, a heavy load is suddenly thrown on the machinery, it is impossible, unless the station be equipped with batteries, to properly care for this load for a considerable time. This point may be illustrated by means of Fig. 86, which shows an actual load curve—from the Philadelphia

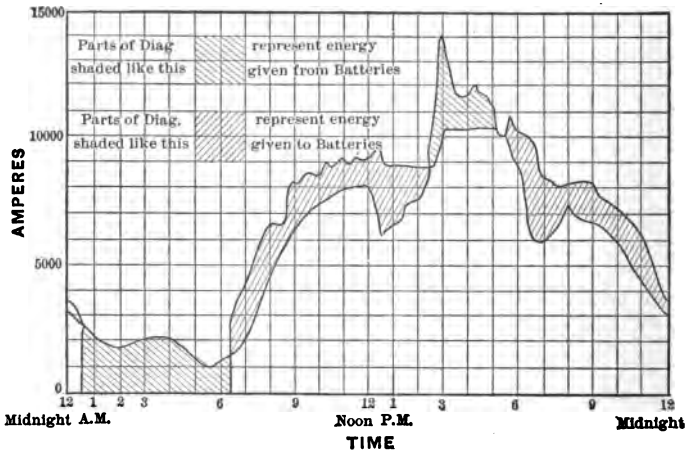

FIG. 86.

Edison station—for a day in May, 1897, when, because of a sudden storm, the load was thrown on very quickly, the peak of the load being higher than usual. It should also be noted that in case of a breakdown, the battery is ready to carry the entire load for the short time necessary to start up another unit. This is an advantage which will not appeal so much to an outsider, perhaps, as to a man intimately acquainted with station management.

Where accumulators are used as storage reservoirs, it has been found that a floor space, approximately 10 yards square, will suffice for storing 1000 kw. hr. Such a reservoir will cost less than those used for either air, steam, or water; the depreciation will be less, and the life will be longer. The pressure, moreover, will be constant, thus enabling lamps of 2.5 watts per candle to be used, which represents a saving of 20%. Moreover, steam storage is not a true reserve, only relieving the boilers, while batteries are a true reserve, delivering the electricity directly and under conditions of high economy.

Many engineers claim that the great trouble with storage batteries is their low efficiency. In the Boston station, however, it has been found that the watts lost by the inefficiency of the battery is made up more than fourfold by the better efficiency of the steam plant. In Hamburg, the loss in the accumulators is only 1.2% of the average amount of electric energy generated during the year. Manufacturers will guarantee the efficiency of a battery, when operated in parallel with a dynamo, to be greater than 75%. Moreover, foreign experience has proven that the use of accumulators involves a saving of at least 15% in fuel. According to the *New York Electrical Review* for Oct. 16, 1895, a battery plant, costing \$150,000, when worked in connection with the trolley system, will show a net increase of \$100,000 in earnings.

4. *For the equipment of annex stations.*—In cases where a heavy load is required, at some distance from the central station, it has been the practice in the past

either to install a separate station at that point, or to run heavy feeders to the centre of distribution. The consequence of the latter alternative being taken has been heavy losses in the feeders, owing to the large currents transmitted, and heavy interest charges for the conductors. Now, however, by the use of batteries, much smaller conductors are required, on account of its not being necessary to carry the current equal to the maximum load, thus reducing the interest charges. Moreover, a high tension current would probably be employed, by which the line losses would be still further lessened. The battery in this case would act as a transformer, being charged in series and discharged in parallel.

Manchester, New York, Boston, Brooklyn, and Philadelphia afford notable examples of accumulator substations, New York having two such stations.

Another method which has been developed by M. Nodon is to use accumulators in place of resistances, particularly with arc lamps. In such cases a considerable portion of the current is irrecoverably wasted in heating the rheostat, while if a battery of accumulators be substituted for this dead resistance, all the waste current may afterward be utilized. The plan possesses the further advantage of affording a much more constant light.

#### EXAMPLES OF STORAGE BATTERY INSTALLATIONS

##### ZURICH

The first example of accumulators being used in a railway power station was at the power plant of the Zurich-Hirslanden Railway, in Switzerland. The in-

stallation consists of 270 Tudor cells, connected in parallel with the generator. When the line was first installed, complicated automatic switches were used, to regulate the number of cells in circuit, but in February, 1895, these switches were removed, and the battery was connected directly in parallel with the line. The batteries have been in use for  $2\frac{1}{2}$  years, with as yet no signs

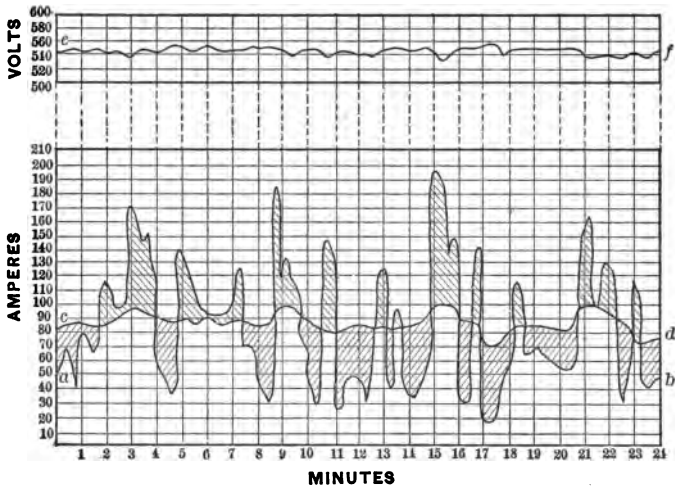

FIG. 87.

of deterioration. The coal consumption is 3.9 pounds per car-mile, which, when the smallness of the entire plant—a steam engine of only 90 H.P. being used—and the exceptionally heavy grades are considered, is extremely small.

Fig. 87 shows a load curve taken from this plant. The line *ab* represents the battery load curve; *cd* the generator load curve, and *ef* the voltage curve. It will

be noticed that the E.M.F. varies only between 535 and 560 volts, and that *cd* averages 85 to 90 amperes.

#### DOUGLAS-LAXEY RAILWAY, ISLE OF MAN

On this road the battery station is at Groudle, nearly midway between the two generating stations. A battery of 240 Chloride cells is employed, capable of yielding, at 500 volts, 70 amperes for 9 hours, 140 amperes for 3 hours, or 300 amperes for 45 minutes. The battery is placed in parallel with the line, charging or discharging according to the demands of traffic. By means of a "booster" in the station, it can be brought up to full charge at any time. During the winter, when only two cars daily are run, the accumulators furnish the entire power, being charged once a week.

#### THE MOUNT SNÆFEL LINE, ISLE OF MAN

Here 246 Chloride cells are used, capable of furnishing, at 550 volts, 176 amperes for 3 hours, 112 amperes for 6 hours, or 72 amperes for 12 hours. The battery is connected, and used in a manner similar to that of the Douglas-Laxey road, including the minimum winter load.

#### CHESTER, ENGLAND

In this installation the three-wire system is employed, and three direct-driven, shunt-wound, Parker generators are used, giving 184 amperes at 440 volts. Two batteries, each of 115 K-type E.P.S. cells, are employed, their normal capacity being 300 ampere-hours at a 5-hour rate. They will also give 240 ampere-hours at a 3-hour

rate, and 60 ampere-hours at a 0.5-hour rate. These results are obtained with an electrolyte temperature of 55° F. Each cell contains 25 plates in glass jars. The cells are supported by oil-insulators on dry-wood bearers, and are placed in parallel rows of two tiers each.

In each battery circuit, on the switchboard, is a regulating switch interlocked with a "booster" reversing switch. This reversing switch enables the "booster" E.M.F. to be added to that at the "bus-bars" on charge, or, on discharge, to that of the battery. All the switchboard connections are of copper, but all battery connections are of brass, painted with an acid-proof enamel, blue for the positive and red for the negative connections.

#### EDINBURGH

Six direct-connected, bipolar, shunt-wound machines, with drum armatures, deliver current to the two sides of the three-wire system at 270 volts. Two similar generators, of smaller size, used as balancing machines, deliver current at 135 volts. The battery consists of 132 Crompton-Howell cells, 31 plate type, with a capacity of 1000 ampere-hours at a 5-hour rate. Lead-lined containing-cells are used, resting on glass oil-insulators on wood bearers. The battery is divided into two half-batteries, positive and negative, arranged in four rows of two tiers each, on cast-iron stands, the 8 "hospital" cells being on a separate stand. The 26 cells in each half nearest the middle wire are used as regulating cells, and are placed in parallel with each other as occasion demands, the connections to the regulating switchboard

being by solid copper rods. The battery room is a well-lighted, well-ventilated room, with a fire-proof floor which is covered with acid-resisting asphalt. Provision is also made for a second battery, of similar size, in case of necessity.

This method of connecting the central cells in parallel, while necessitating a more complicated system of connections than with the usual method of cutting out cells on the outer end, renders the manipulation exceedingly simple, and does away, to a great extent, with the troublesome charging of the back cells. By this arrangement of battery regulation, all of the cells in the battery are always used, which is not the case with back E.M.F. cells. In order that charging may go on at light load, when there is only a small drop on the feeders, the "hospital" cells are connected, four on each side of the system.

Under normal circumstances, the battery is charged during light load, the charging current varying with the external load, so as to keep the engine load constant. During heavy load, the batteries are kept, as far as possible, idle, it being only in the case of a "peak," and when the generators are shut down, that the batteries are subjected to a high rate of discharge.

#### MANCHESTER

The electric-light works of Manchester, England, have recently added to their plant a storage-battery sub-station, situated about one mile from the generating station, the five-wire system being used. A motor



generator, which carries the normal charging current of 300 amperes, is used to raise the E.M.F. from 410 to 590 volts. There are 224 cells divided into 4 series of 56 cells each, each battery being again subdivided into a main battery of 44 cells, and a regulating battery of 12 cells, with a total capacity of 1250 kw. hr. The normal rate of discharge is 300 amperes for each battery, and the maximum, 600 amperes. The battery carries the entire load after midnight, the third shift of hands, from 10 P.M. to 6 A.M., being almost dispensed with. On Sundays, the battery carries the entire load up to 4 P.M., in addition to its regular night load, thus relieving the second shift of men.

The plates are supported in the cells by means of glass hangers, and are separated from each other by solid glass rods. The containing cells are supported on iron and timber stands, the battery being insulated throughout with duplex oil-insulators. Connections are made to the switchboard by means of solid copper rods carried around the walls on porcelain insulators which are fixed to iron supports.

#### BELFAST

The plant in the engine room consists of four 120 I.H.P., tandem, double-acting, horizontal gas-engines, rope-connected to four 60 kw. Siemens' generators. There are, likewise, two 60 I.H.P., single-cylinder, double-acting, horizontal gas-engines, rope-connected to two 26.4 kw. Siemens' generators; also, two 150 I.H.P.,

four-cylinder, single-acting, high-speed, vertical gas-engines, direct-connected to two 72 kw. Siemens' generators. Ignition is made by means of hot tubes, which are of ordinary wrought-iron, nickel-steel, and porcelain. For starting, the generators are connected to the batteries, and run as motors. The dynamos give 240 amperes at 240 volts, 220 amperes at 120 volts, and 300 amperes at 240 volts respectively.

All the generators are shunt-wound, bipolar machines, with drum armatures. The two small machines have double-wound armatures, the windings being connected to separate commutators. By means of a plug switch-board, these windings can be connected either in series or parallel, so that the machines can be run at either 120 volts for balancing, or at 240 volts across the system. The three-wire system is used.

The battery consists of 126 E.P.S. cells, of the 34-K, or heavy-discharge type, divided into two sets of 63 cells each; the normal capacity of the cells being 500 ampere-hours at a 5-hour rate. There are also 8 "hospital" cells, which can be used either to assist weak cells, or can be put in series with the main battery. The regulation in this station is accomplished by putting the cells at the middle-wire end of the positive battery in parallel with cells at the middle-wire end of the negative battery, the other end of the batteries being connected through ammeters and switches to their respective "bus-bars." In addition, the neutral wire is shifted either toward the positive or negative end of the batteries. The plates are contained in lead boxes, which are supported, by means of glass oil-insulators,

on four rows of wooden stands. The connections from the battery consist of bare copper rods, supported by oil-insulators, suspended from the roof.

#### BIRKENHEAD

This station is arranged for the three-wire system, but uses at present only two wires with a pressure of 230 volts. Three 80 H.P. engines are direct connected to three 50 kw., shunt-wound, Crompton dynamos, with an output of 200 amperes at 250 volts. The battery consists of 136 E.P.S. cells, of the K-50 type, with a capacity of 750 ampere-hours at a 5-hour rate, or 400 ampere-hours at a 1-hour rate. Lead containing-boxes are used in pitch-pine trays on glass insulators. The battery is subdivided into the main battery of 126 cells, and the "hospital" battery of 10 cells. Regulation is accomplished by cutting in or out the end cells, of which 19 at each end, or 38 in all, are connected to the regulating switches.

The cells are arranged in three long rows of two tiers each, on pitch-pine bearers, supported by cast-iron standards. These stands rest on thick stone slabs, the slabs resting on a concrete foundation. Over this concrete foundation, and surrounding the slabs, is placed a layer of roofing felt, then a layer of bitumen, and the whole floor is then covered with slate. This acid-proof floor is ridged to give drainage.

The end cells are connected from row to row by copper rods, and regulating leads, also of copper, run over the cells in wood cleats on ebonite insulators, and are

supported by bearers resting on iron girders. Space is provided for a similar battery, when the change to the three-wire system is made.

## MERRILL

In this station, which furnishes power for both lighting and railway circuits, the generators are all run from the same shaft, the prime mover being water power. It will be readily seen that under such circumstances

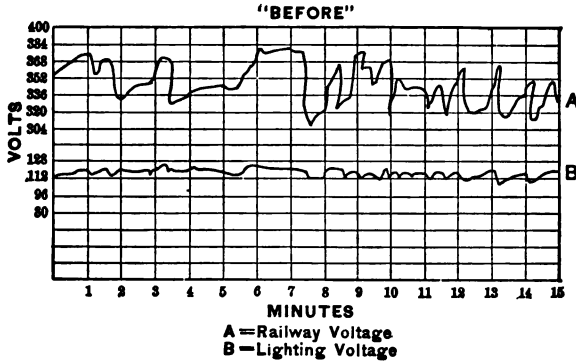

FIG. 88.

the voltage would be far from steady. The advantages derived from the introduction of storage cells are illustrated in Figs. 88 and 89, the curves being taken before and after the installation of the batteries. Before the batteries were installed, only one car could be run during the heavy lighting hours, and then far from satisfactorily. The battery was installed for the double purpose of increasing the lighting capacity, and for regulating the railway voltage; water-wheel governors had previously been tried for this latter purpose, but

were found to be unsatisfactory. The battery is situated in a sub-station, about  $\frac{3}{4}$  of a mile from the power station, and about  $\frac{1}{4}$  of a mile from the centre of distribution for the lighting service.

The battery contains 240 Chloride cells, of 11-F type, with 500 ampere-hours capacity at a 10-hour rate. It is divided into 4 series of 60 cells each, which can

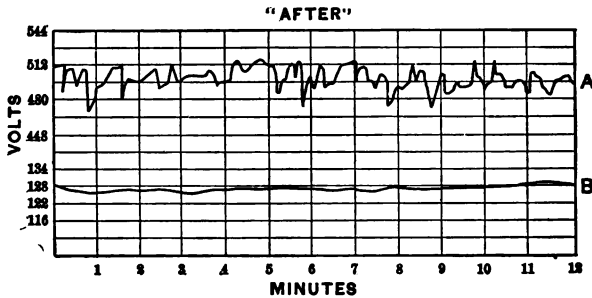

FIG. 89.

be connected 4 in series for the railway circuit, or 2 in parallel for the lighting circuit which is arranged upon the three-wire system. A variable resistance is put in circuit between the battery and railway, for cutting down the voltage when the battery is fully charged. Two large, double-throw, three-point switches connect the battery to the railway, or to the three-wire lighting system.

#### HARTFORD

The Hartford Electric Light Co. generate current at 500 volts, — three-phase system, — at the power station on the Farmington River, 10.8 miles distant from the city. This is raised by means of "step-up" transform-

ers to 10,000 volts, and is transmitted over six #0 wires,—two in multiple for each phase,—1200 kws. being transmitted in this way. At the Pearl St. station the pressure is reduced to 2400 volts, and the current is changed from three-phase to two-phase. Most of the energy received at the Pearl St. station is used for three purposes. It supplies the current to all the alternating current lighting and power system. It supplies the current to the rotary transformers at the State St. station for charging the storage battery, and it supplies the current to the three-wire, direct-current system.

At the State St. station is placed a battery of 130 Chloride cells, 65 on each side of the system. Each cell contains 30 positives and 31 negatives, the plates being made in two parts, each  $15.5 \times 15.5$  inches. Manchester positives and Chloride negatives are used in a lead-lined oak containing-cell. The normal capacity is 8500 ampere-hours at a 5-hour rate, a 1.25-hour rate being allowable if necessary. Twenty end cells on each side are connected to the regulating switches, the switches being mounted vertically, and similar to those installed by the Electric Storage Battery Co.

The diagram (Fig. 90) shows the station operation for Dec. 12, 1896. The line enclosing *B* and *C* spaces show the current taken from either the rotary converter or battery for line use. As shown, at midnight the consumption had fallen to 350 amperes, and ran along at this rate till 6 A.M., when it began to rise, and at 8.30 had an output of 1550 amperes. During

this time the batteries had been charging from the converters (see *A* space). At 8.30 the battery took the peak of the load, and carried it for 1.5 hours. At noon the demand dropped from about 1400 amperes to 750 amperes for one hour, during which time

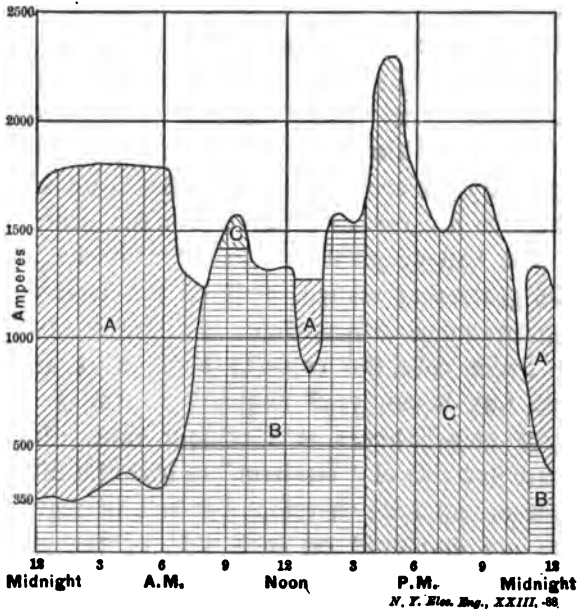

FIG. 90.

*N. Y. Elec. Eng., XXIII, '02*

the battery was charging. From 1 to 3 P.M. the river current, as it is termed, was all required by the lines, and the battery remained quiet. At 3.30 P.M. the rotary transformers were shut down and the battery took the entire load till 11 P.M., when it was shut down and charging began, the rotary transformers also furnishing all line current.

## BOSTON

In 1897 the Boston Edison Co. already had three battery plants in service, and were installing a fourth one. The First, Second, and Third generating stations are situated at the points of an approximately equilateral triangle; the distance from the First to the Third stations being 3800 feet, and from the Second to the Third 4200 feet. The First and Second are each connected to the Third by tie lines of 3,000,000 circular mills capacity, on each side of the three-wire system. The batteries are run in parallel with the generators.

The first battery plant was installed at the Third, or main, generating station, 90% of the total output being generated at this station. The battery consists of 140 Tudor cells, the capacity being 4125 ampere-hours at 1.25 hours, 5148 ampere-hours at 3 hours, and 6940 ampere-hours at a 10-hour rate. In this station are five sets of "bus-bars," to give the different pressures as required; therefore five sets of regulating switches are employed on each side of the system. The switches consist of 31 contacts to which 30 of the cells are connected in each battery, and are entirely automatic.

The second battery is installed at the First station, and is the largest of the four batteries. It consists of 144 Tudor cells, the capacity being 8250 ampere-hours at 1.25 hours, 10,296 ampere-hours at 3 hours, and 13,880 ampere-hours at a 10-hour rate. The containing-cells are lead-lined wooden boxes, each containing 37 frames. Each positive frame contains 16 plates,



7 inches square; and each negative 4 plates, 14 inches square; the plates being secured in their frames by soldered lead strips. The elements stand on glass plates set on edge, leaving a space of 6 inches below the elements for the sledge. Each cell contains 640 litres of acid, and measures 3 feet 10 inches  $\times$  3 feet 4 inches  $\times$  3 feet; the cells are arranged in six rows on three floors of the building, and stand on porcelain insulators. The floor of the room is made of slate. Connections from the cells to the switchboard are by copper bars, 0.5 inch thick, and from 3 to 6 inches broad. This station has three sets of "bus-bars," and consequently three sets of regulating switches on each side of the system. As in the other stations, the regulation is entirely automatic, being accomplished by 0.25 H.P. electric motors.

The third battery is installed at the Fourth, or Scotia St. station, and is distinguished by being situated in a fashionable residence district, and is entirely a sub-station, containing no generating machinery whatever. It is 7000 feet from the First station, and nearly 11,000 feet from the Third or main station. The current is sent from the Third to the First, and from there to the Fourth station, at a high potential; the same generators charging the First station batteries as well as the Fourth. The battery consists of 140 Chloride cells, resting on four "petticoat" insulators, of which the capacity is 3000 ampere-hours at 1 hour, 4500 ampere-hours at 3 hours, and 6000 ampere-hours at a 7.5-hour rate. The containing-cells are hard pine tanks, 18  $\times$  22  $\times$  38.75 inches, inside measurement, lined with

5-pound lead. Each cell contains 21 plates, Manchester positives and Chloride negatives being used. Twenty-four cells on each side of the system are connected to the regulating switches by hard-drawn copper bars,  $3 \times 0.5$  and  $1.5 \times 0.5$  inches cross-section. These bars are supported on porcelain insulators, resting on wooden hangers, the hangers being supported from the floor by iron pipes. The battery room floor is 12 inches concrete, with a regular cement finish.

The fourth battery is at the Second station, and will have a capacity of 4000 ampere-hours at 1 hour, 6000 ampere-hours at 3 hours, and 8000 ampere-hours at a 10-hour rate.

#### NEW YORK

The Edison Electric Illuminating Co. of New York have at present three storage battery plants,—one at the 59th St. station, another at the 12th St. Annex, and a third at the new Bowling Green station. The generating plants of the entire system, with the exception of that at the 26th St. station, have been shut down several times over night, or over Sunday, in order to test the practicability of running the system from one generating plant, with the aid of the 12th St. batteries, during the hours of minimum load. The results show that this is quite practicable, and with the aid of the Bowling Green station it is expected that considerable economy will be developed in this way.

The 59th St. station contains the first successful storage battery installation in American Electric Light stations. The battery is of the English Crompton-

Howell type, with a capacity of 3000 ampere-hours at 3 hours, or 2000 ampere-hours at a 1-hour rate.

In the 12th St. station, 150 cells, having a capacity of 8000 ampere-hours at 10 hours, 6000 ampere-hours at 3 hours, and 4000 ampere-hours at a 1-hour rate, have been installed. Each cell contains 39 elements, the positive plates being of the Tudor and the negative of the Chloride type. The battery is arranged in four rows of two tiers each, resting on wooden bearers supported by iron standards. By a system of tie feeders, this battery can be charged either from the 26th St. or the Duane St. stations. The 12th St. station contains, besides the battery plant, a complete steam equipment, which is run only during one watch of maximum demand. The battery supplements this, besides taking the entire load during the remainder of the day. Fig. 91 shows the diagram of connections for this station, and Fig. 92 that for the Bowling Green Annex.

The Bowling Green Annex likewise contains 150 cells, 75 on each side of the three-wire system. In this case, each cell contains 33 elements of the Manchester positive and Chloride negative type, in a lead-lined, poplar, containing-tank, which measures 40.75 × 20.5 × 30.5 inches. The tanks rest on four "petticoat" insulators, which in turn rest on 6-inch vitrified tile. The capacity of the battery is 2000 ampere-hours at 1 hour, 3000 ampere-hours at 3 hours, and 4000 ampere-hours at a 10-hour rate. There are 20 regulating cells at each end of the battery, each of which is separately connected to a block on the ordinary regu-

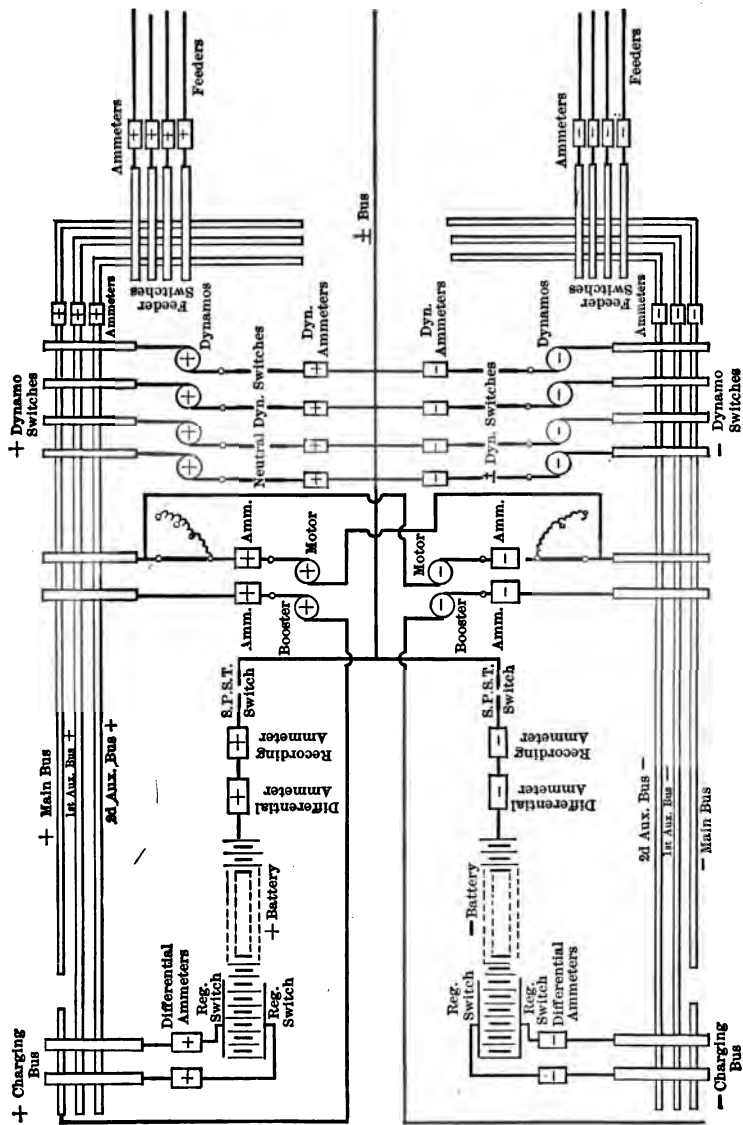

FIG. 91.

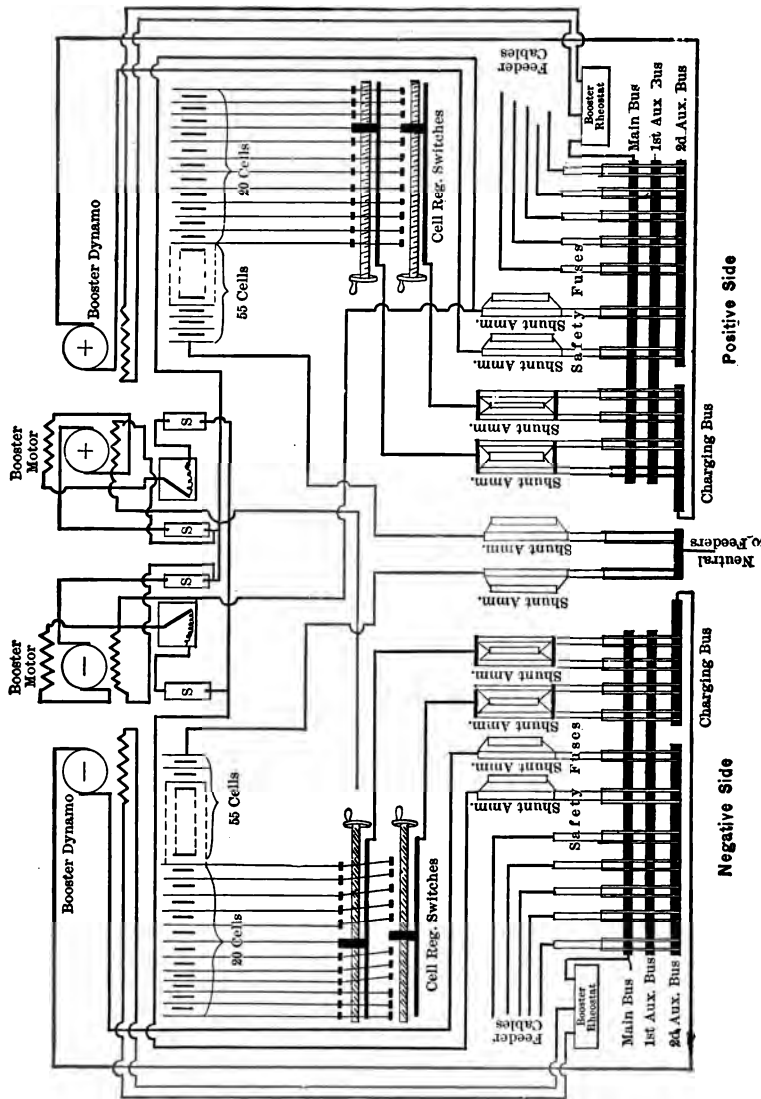

FIG. 92.

lating switch. Two regulating switches are connected in multiple on both sides, thus enabling the battery to be discharged at two potentials, or to be charged and discharged at the same time.

The battery room floor contains, first, a layer of concrete 18 inches thick, then a layer of pitch and felt, then a series of vitrified hollow tiles, for conducting the feeding cables, then more pitch and felt, then a 12-inch layer of concrete, and finally a layer of vitrified white tile. This elaborate flooring is necessary because the battery is situated in the sub-basement of the Bowling Green Building, the floor of which is below the water line. The waterproofing on the side walls is retained in place by a wainscoting of slate, securely fastened to the brick walls at the top, and embedded in the concrete at the floor level.

All connection between the cells, and between the regulating cells and the switchboard, is by means of copper bars 0.5 inch thick by 3 inches wide. The area of all joints is 18 square inches, and each connection is made by means of two  $\frac{7}{8}$ -inch bolts. These copper strips are supported on porcelain insulators, which rest on hangers, or horizontal iron beams. Fig. 93 illustrates the battery room for this station.

#### BROOKLYN

The Brooklyn Edison Co. have, at the time of writing, one battery plant in complete operation, and are installing a second and larger battery. The former is located in what is known as their Second District



FIG. 93.

station, located in Lexington Ave. The generating machinery is only run during the period of maximum load; at other times, the station is used as a battery sub-station, in connection with the First and Third District stations, to which it is connected by tie lines. The plant, illustrated in Fig. 94, consists of 160 Chloride cells, containing Manchester positive and Chloride negative elements. The capacity is 8000 ampere-hours at 10 hours, 6000 ampere-hours at 3 hours, and 4000 ampere-hours at a 1-hour rate. Thirty end cells, on each side of the three-wire system, are connected to the cell-regulating switches, which are located in the battery room, and the main distributing board is placed on the main floor of the building, immediately under the battery room. The regulating switches are operated, as usual, by electric motors, connected thereto by worm gearing. Two 16-C.P. lamps are connected in each motor-control circuit, one lamp being located on the main distributing board and the other in the battery room. When the regulating brush is travelling from one contact to another, these two lamps are in series, and burn dimly; but when the brush is entirely on the contact, one cell having been cut in or out, one of the lamps is extinguished, and the other burns brightly, thus giving an indication of when the motor should be stopped. In addition to this, there is an indicator telling the number of cells in circuit, which works on the principle of the Wheatstone bridge.

Charging is accomplished either by means of the machines at the station, or by means of tie lines from





FIG. 94.

the other stations, a "booster" being used in either case, as necessary.

The battery being installed is to be located at what is known as the Citizens' station, and is to consist of 156 Chloride cells, with a capacity of 12,000 ampere-hours at 10 hours, 9000 ampere-hours at 3 hours, and 6000 ampere-hours at a 1-hour rate.

#### PHILADELPHIA

The Philadelphia Edison Co. have lately installed the largest individual storage battery plant in the world. At Hartford the cells are larger, but they are fewer in number, and their total output is, therefore, less. The Philadelphia plant consists of 160 Chloride cells, containing 57 plates each,  $31 \times 15.5$  inches. The capacity of the battery is 15,200 ampere-hours at 10 hours, 11,250 ampere-hours at 3 hours, and 7500 ampere-hours at a 1-hour rate. The plates are supported on glass sheets, in ash containing-cells, which are lined with 4-pound lead. Thirty cells on each side of the three-wire system are connected to the regulating switches by rolled copper bars, with a sectional area of 2 square inches. These are supported on porcelain insulators, which are mounted on channel irons hung from the ceiling. All joints are bolted together by four  $\frac{5}{8}$ -inch bolts, and are treated with Edison-Brown plastic alloy. All other connections are made by means of lead "bus-bars," reinforced with copper strip. All copper connections are painted with an acid-proof enamel paint. The regulating switches, which are operated by electric motors,

are placed on the outside of the battery room wall. The main switchboard is located in the dynamo room, on the second floor, immediately under the battery room. Figs. 95, 96, and 97 illustrate, respectively, the battery room, the switchboard, and the cell-regulators, for this station.

On the battery room floor was first laid concrete, then three thicknesses of paper coated with pitch to render it waterproof, then chemical brick laid in cement for one-half its depth, the other half being filled with hot pitch. The aisles are graded so that all liquid will drain off in channels provided for that purpose. The cells are supported on eight double "petticoat," porcelain insulators, set in vitrified tile, to raise them slightly above the floor.

That portion of the main switchboard which is devoted to the battery connections is supplied with the following instruments :

- 2 motor-control switches.
- 2 cell-regulating switch indicators.
- 2 ammeters; for the cell-regulating switches.
- 1 ammeter; for the battery control.
- 1 voltmeter with five-point switch; to indicate pressures on the two "bus-bars."
- 2 cell-regulating switches (on the "charging-bus").
- 1 low-reading voltmeter with 30-point switch (to indicate the voltage of each regulating cell).
- 7 knife switches.

These instruments are all in duplicate, one set for each side of the system. As a general rule, the battery



FIG. 95.



FIG. 96.



FIG. 97.

carries the entire load from 12.30 A.M. to 6.30 A.M., about 8000 ampere-hours being taken out; from 6.30 A.M. to 4.30 P.M. the battery is charged; at 4.30 the peak commences, and lasts till about 6 P.M.; from then on till 12.30 A.M., the battery is charged, to be ready for the night load. Fig. 86, which was taken from this station, shows a load curve. This is not the normal load curve, however, because of a sudden thunderstorm.

In 1890, when the Union Traction Co. of Philadelphia decided to extend their lines, it was found that either a new power-house, or an accumulator annex, would have to be built, as the needed addition to the existing feeder system would require such an expenditure for copper as to render it commercially impracticable. The cost of copper alone would have been about four times as great as the cost of a battery sufficient to meet all requirements. The erection of a new power-house was out of the question, because of the heavy operating expenses. The capacity of the power-house would have to be about 750 kw., and this, at an estimated cost of \$85 per H.P., would cost about \$85,000. The total cost of the annex, including the changes in cables, was about \$50,000. Before the extension was made, the pressure at the end of the system was barely sufficient to operate cars on schedule time, the pressure varying as much as 50%. This condition is clearly illustrated by the frontispiece, and by Fig. 98. After the installation of the batteries the only variation in pressure was between 1 and 5 A.M., when the battery

was taken out of circuit. The installation consists of 248 G-13 Chloride cells, in lead-lined boxes, mounted on two tiers of oil-insulators. All connections are made by continuous weld, no mechanical contacts being employed. The maximum rate is 400 H.P. for one hour.

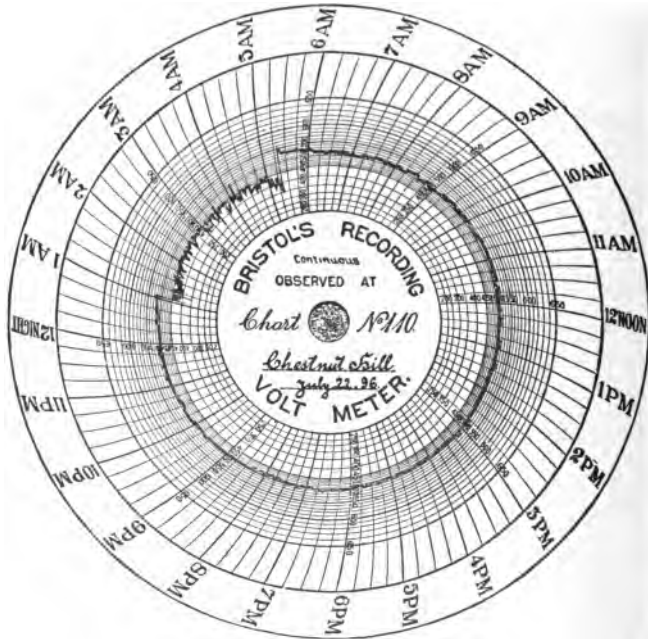

FIG. 98.

Figs. 99 and 100 illustrate, respectively, the battery room, and a load curve for this station. The following data regarding the operation of the installation may be of interest; they are taken from a communication to the Engineers' Club of Philadelphia, made by Mr. Hewitt in December, 1896.



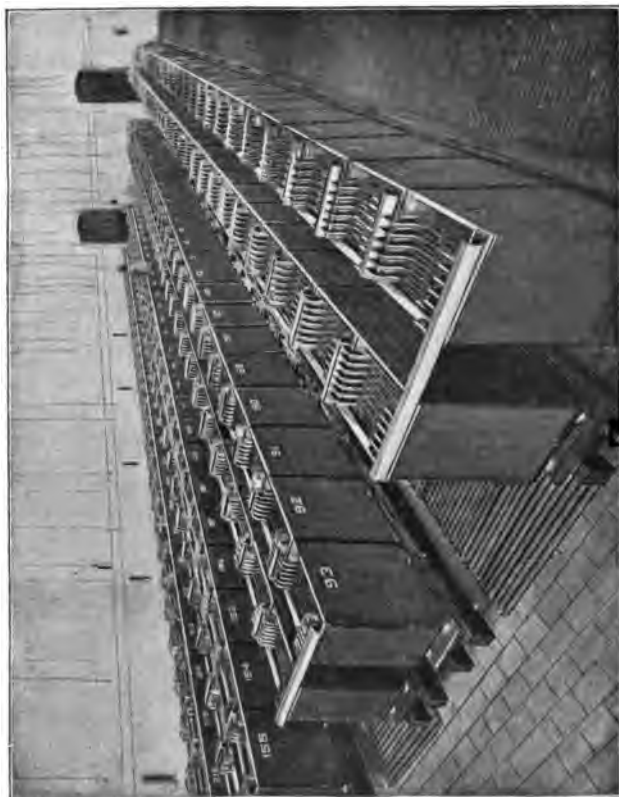

FIG. 99.

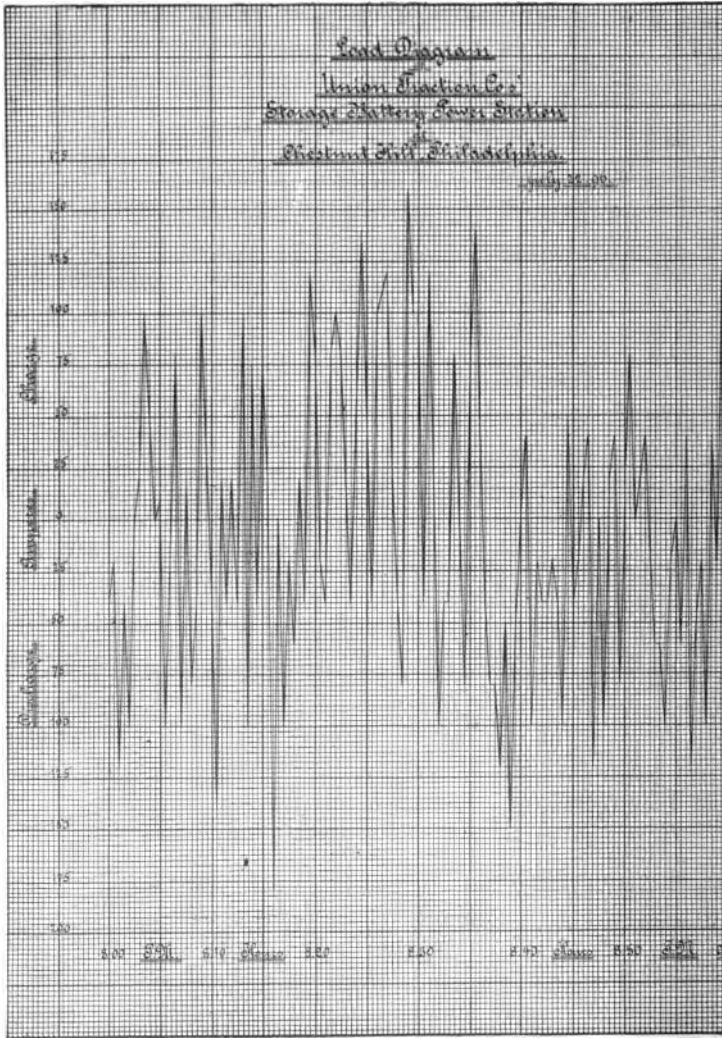

FIG. 100.

The saving in favor of the battery for the year is \$15,633.96.

Highest charge for 24 hours . . . . .	456,000 watt-hours.
Lowest charge for 24 hours . . . . .	312,000 watt-hours.
Average charge for 24 hours . . . . .	385,161 watt-hours.
Highest discharge for 24 hours . . . . .	456,000 watt-hours.
Lowest discharge for 24 hours . . . . .	216,000 watt-hours.
Average discharge for 24 hours . . . . .	329,419 watt-hours.
Average efficiency for the month . . . . .	85.5%
Maximum specific gravity at 6 P.M. . . . .	1.201
Minimum specific gravity at 6 P.M. . . . .	1.184
Average specific gravity at 6 P.M. . . . .	1.192
Maximum specific gravity at 12 P.M. . . . .	1.194
Minimum specific gravity at 12 P.M. . . . .	1.182
Average specific gravity at 12 P.M. . . . .	1.188

This last specific gravity is approximately that preceding the night charge, and is an indication of the amount taken out during the day; it should be borne in mind that at 1.160 the battery is practically empty.

THE COMMERCIAL CABLE BUILDING, NEW YORK.

The battery plant in this building consists of 120-2500 ampere-hour Chloride cells, whose internal dimensions are 20.5 x 26.5 x 20.75 inches. The containing-cells are made of ash. They are lined with lead and painted with asphaltum, and are mounted on glass insulators, resting on hardwood blocks on 4-inch I beams. The cells are arranged three tiers high on one side of the room and two tiers high on the other in order to economize space. Strong running boards are bracketed out from the frames for the use of the attendants. The plates in the cells rest on glass strips, which in turn rest

on leaden legs. Connections between adjacent cells are made by burning the plates to lead "bus-bars"; all copper leads are dipped in lead, as is all steel work and all bolts and riveted joints, to protect them from the battery fumes.

The battery currents are controlled by a 25-H.P., 75-volt "booster," driven by a 240-volt motor. The field of the "booster" is wound with a series and shunt coil. During the day, when the battery is being charged, the series field works against the shunt field, the battery terminal being outside the series coil, that is, between the series coil and the motor load. In this case, if the elevators take a heavy current, the "booster" weakens, which prevents the "peak" being taken from the dynamo, and throws it all on the battery. At night the generators are thrown off, and the battery terminal is changed to a position between the "booster" brush and the series coil. In this case the field connections work cumulatively; and if the elevators draw a heavy current, the series coil builds up the "booster" voltage, so as to compensate for the drop in the batteries. Thus the lamp pressure is maintained at a constant value.

#### OTHER INSTALLATIONS

For the electric railway in Rome, Italy, alternating current from the Tivoli-Rome transmission plant is supplied. The pressure is first reduced by means of a stationary transformer, and is then converted to a direct current by means of a motor-generator having a multipolar field and a single armature. The armature has

collecting rings on one side and a commutator on the other. The battery plant consists of 300 Tudor cells, with 720 kw. hr. capacity. Pressure is kept constant by means of an automatic switching-in apparatus.

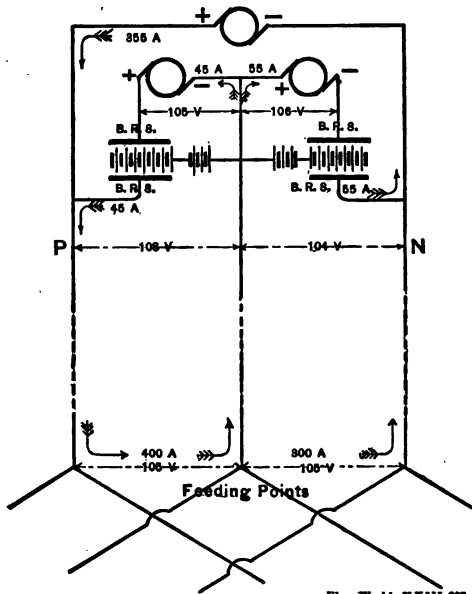

FIG. 101.

In Burnley, England, the three-wire compensating device, shown in Fig. 101, is used. The dynamo generates 230 volts. The compensator consists of two armature coils wound on a single drum, each for an output of 200 amperes at 110 volts. The battery is of 120 cells, of about 500 amperes each. The bars represent regulating switches; thus balancing with only one engine and one dynamo.

On the Zurichberg railway, in Switzerland, gas-engines are used in conjunction with a battery of

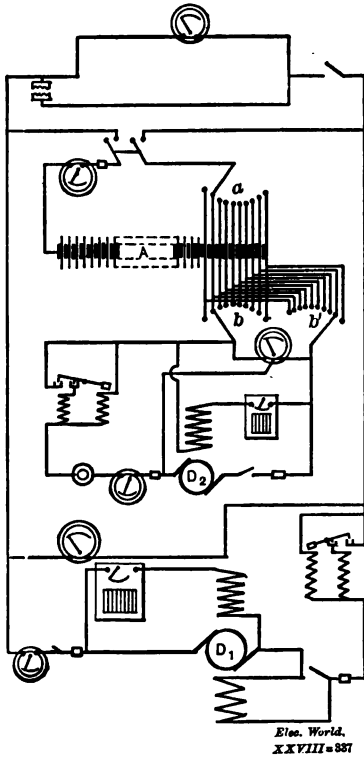

FIG. 102.

*Elec. World.*  
X.XVIII-387

300 Tudor accumulators. The diagram, Fig. 102,

shows the connections. "There is an automatic regulator *ab*, and further a hand regulator *b'*, for the 90 control cells divided into 30 groups of 3 each. The cells are in parallel with the dynamo  $D_1$ ; and  $D_2$  is an auxiliary dynamo, whose field coils are placed between *b* and *b'*, and which charges all cells beyond *a*. The excitation of  $D_2$  changes with the number of cells in circuit. The interrupters are solenoids with mercury cups."

Fig. 103 shows the load curve for Berlin,

in which *a* represents the current curve, *b* the wattage curve, and *c* the charging curve. The maximum charging current is 650 amperes, and the maximum discharge current 1420 amperes.

Fig. 104 shows the load curve for the electric plant in the Chicago Board of Trade, and Fig. 105, the switch-board connections.

SECONDARY BATTERIES IN ELEVATOR WORK

A growing use for secondary batteries exists in connection with elevator work. Many office buildings have been compelled to install their own generating plant, because of the unwillingness of central station managers to accept the load. When the character of the load due to elevator service is considered, this unwillingness will be clear. Because of the large amount of energy con-

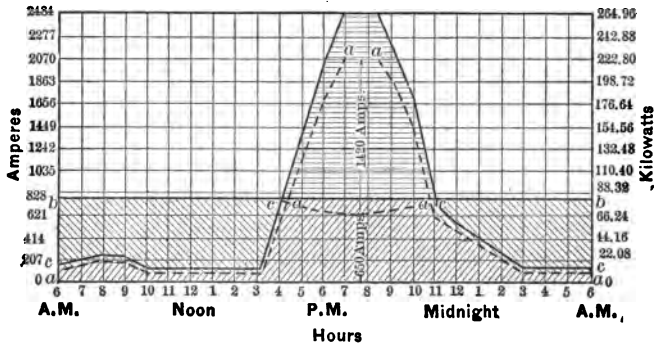

FIG. 103.

sumed, the customers require that the current be given them at the lowest rates; but because of the fluctuating character of the load, which is well illustrated in Fig. 106,<sup>1</sup> central-station men cannot afford this practice. Of late, however, storage-battery plants have been installed, thus changing the load from an undesirable to a most desirable one. The battery suffices for the entire elevator and lighting work, besides putting a steady load on the engines. In some cases the storage battery has

<sup>1</sup> Electrical Engineer, New York, Vol. 23, p. 497.

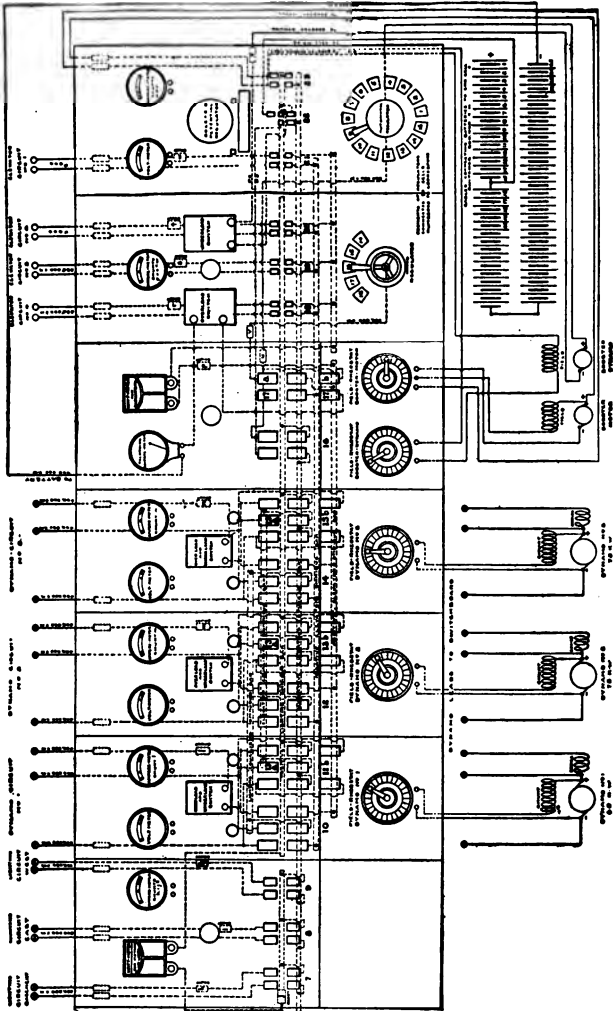

FIG. 105.







been installed and maintained at the sole expense of the owners of the central station, who have placed the

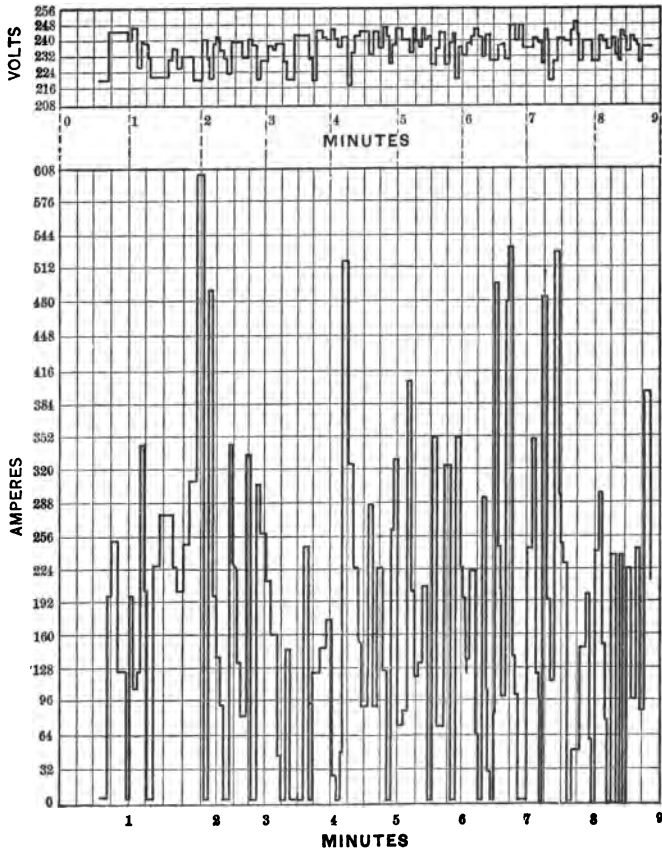

FIG. 106.

meter between the battery and wiring mains in the building and have charged only for the current actually used by the customers.

In some cases "recuperation,"<sup>1</sup> as practised on the Paris Accumulator Lines, is being employed to advantage. In such cases the car, descending by gravity, charges the battery, thus restoring much of the energy used during the ascent.

An interesting experiment is being conducted on the Manhattan Elevated Railway, of New York City; that of carrying the battery plant on the train itself, rather than installing it at sub-stations along the line of the road. The battery consists of 248 Chloride cells of 400 ampere-hours' capacity, the total weight being 10 tons. The batteries are all connected in parallel by a third rail, so that all work in unison for any variation of load in their immediate vicinity. In this way the total amount of battery is evidently less than if it were installed in a sub-station. Moreover, the load on the feeders will be the average load and steady, the battery taking charge of the heavy load that comes with starting. In this way the cost of copper for the feed wires is greatly reduced and the pressure at the motor is kept constant. On all curves, crossings, and in and out of the car-barns, the third rail can be dispensed with, since the battery is capable of doing the entire work at these places.

#### THE STORAGE BATTERY IN TELEGRAPHIC WORK

The field which, from a practical, scientific, and economic point of view, holds the largest possibilities for the employment of accumulators is the field but lately exclusively occupied by the primary battery, as

<sup>1</sup> *Vide* pages 206 and 215.

applied to telegraph and telephone stations, police and fire alarm, and all signalling systems. Those stations whose business is not large enough to warrant the installation of a generating plant, are fast equipping with a battery of accumulators. The low first cost, the small amount of space occupied, — about one-fourth of that required of a primary battery to do the same work, — the constancy of the E.M.F. and internal resistance, the obviation of the troubles due to creeping salts and corroding connections, are a few of the advantages which recommend a storage battery for any of the above purposes. It is a fact, as McRae has said, that “the poorest type of lead secondary battery that is on the market to-day is capable, if properly installed, of giving better service than the best type of primary battery.”

In July, 1895, 3116 storage cells were performing the work previously required of 20,407 primary battery cells. The estimated cost of the latter, not including freight, is \$10,203.50, while that for the former is between \$8400 and \$8500. When the element of freightage is considered, the difference is still greater. A small amount will have to be added to the accumulator cost, because of auxiliary apparatus required by a storage battery installation, and not by a primary battery. This addition will, however, be very slight, being seldom over 15% of the cost of the battery.

As regards the cost of maintenance of the primary battery, it may be stated that this will average about \$1.50 per year. William Finn states that “the materials consumed in a single cell of the gravity battery furnishing current for the quadruplex circuit would, in

the course of a year, amount, *at the lowest estimate*, to \$1.10." J. B. Stewart puts the cost of the gravity batteries used in the "West Shore" railway telegraph system at \$1.65 per annum. The maintenance cost of the storage battery is made up of three factors: the cost of charging current, the interest on first cost, and the depreciation of cells. The first factor is somewhat difficult of estimation. Taking as a basis, however, the cost at which this current could be bought from regular electric lighting stations, it has been estimated that the cost of current equivalent to that furnished by a gravity cell during one year would be about 9 cents. The addition of 2.5 cents for each of the other two factors brings the total maintenance cost up to 14 cents, as against \$1.50 for a primary battery.

According to Mr. Finn, "the elaborate series of engines and dynamos now furnishing the electromotive power in many of our telegraph offices could, in the opinion of expert authorities, be replaced with accumulators with considerable economy in capital expenditure, and an ultimate saving in the cost of maintenance." The great flexibility of an accumulator is one of the main points of superiority of a storage-battery plant over a dynamo.

Storage batteries are being introduced in telephone work, the battery being installed at the subscriber's station, and charged, when the line is not in use, from a generator at the exchange. When a call is made, and the line is switched for conversation, the central generator is automatically cut out, and the battery switched in.

Perhaps the earliest storage battery to be used for

telegraphic work was introduced, in 1892, in the Burry printing telegraph,—the system used by the Stock Quotation Telegraph Co. At that time electrical experts were almost unanimous in their opinion against the use of storage batteries for this purpose. Mr. Burry, however, believed in it, and installed one on six months' trial. It proved to be a complete success, in regard to quality of current, labor-saving, and general economy.

Storage batteries are also being largely introduced in fire-alarm work, as evidenced by the fact that 10,422 battery cells have been introduced during the last two years, and 47 cities are now equipped with storage systems.

The first large storage battery installed by the Western Union Telegraph Co. was in its offices at Atlanta, Ga. In this installation 700 Chloride cells perform the work previously requiring 8000 gravity cells. This plant includes 344 cells of 75-ampere-hours capacity; 172 50-ampere-hour cells; and 172 25-ampere-hour cells,—all used on the main line; also 12 cells of 250-ampere-hours capacity, exclusively for the local circuits. These 700 cells are divided into two equal sets, which are charged and discharged on alternate days; the sets in turn being divided into 8 groups of 43 cells each, which are charged in multiple series, and discharged in series. The cells are charged from the 500-volt mains of the Georgia Electric and Power Co.; two motor dynamos being used to reduce the line E.M.F. to the correct charging pressure. One of these, a 7.5-H.P. motor dynamo, used for the main line battery, transforms to

110 volts; and the other, a 1-H.P. for the local cells, transforms to 16 volts. Fig. 107 shows the connections.

At Washington, the second large Western Union installation, 724 Chloride cells are used, divided as follows : 398 cells of 50 ampere-hours, 320 12.5-ampere-hour

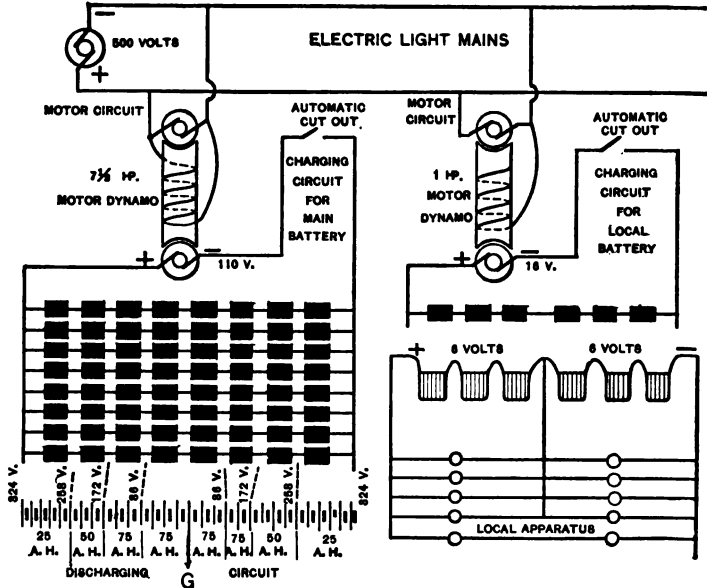

FIG. 107.

cells, and 6 125-ampere-hour cells. The main battery of 640 cells is divided into 16 groups of 40 cells each. This is divided into two sets, which are charged and discharged alternately, as in the Atlanta installation. The 78 cells comprising the "short wire" battery are a part of the 50-ampere-hour set. They are likewise divided into two sets, differing, however, from the preceding by being charged in series and discharged in multiple.



The main battery is both charged and discharged in multiple. No transforming machinery is needed in this station, as the charging E.M.F. is 110 volts. These 724 accumulators replace 7300 gravity cells.

At Albuquerque, N.M., is probably the first large installation dependent entirely upon storage batteries. This plant consists of 360 Chloride cells, of 20 ampere-hours' capacity at service discharge, divided into 9 sections for convenience in charging. There are also 12 cells of 100 ampere-hours capacity at service rates for supplying local circuits; the smaller cells being for main line service. The cells are charged to 2.5 volts per cell, and discharged to 1.8 volts. A resistance is placed in each discharge circuit to prevent cells from short-circuiting.

The cells are placed in two racks, each having three rows of double shelving, the highest being 4.5 feet above the floor. The total floor space occupied measures 13 feet by 5 feet. These cells supersede 900 Callaud cells. Formerly, to have increased the service would have required an additional equipment of Callaud cells, while now an additional service only requires more frequent charging. The charging current is taken from the local lighting company's incandescent circuit, and is controlled by dynamo regulators.

At the central station in Paris, 11,000 Callaud cells of the larger type were required to do the work now performed by 340 accumulators. This battery is divided into six distinct sets; two sets each of 50-60 ampere-hour Laurent-Cély cells, and four sets each of 60-72 ampere-hour Tudor cells. Two of the Tudor sets—one

each for the positive and negative side— supply day current for main line and local circuits, and to five Baudot distributors. The other Tudor sets act as a reserve, while the two Laurent-Cély sets furnish current for the night service, which is comparatively light. The cells are placed on two strong trestles, arranged in parallel rows of 15 cells each, two tiers high. All connections are thoroughly soldered. As the charging generator gives only 70 volts, the batteries are charged in multiple series; three groups of 20 elements being arranged.

In the fire and police telegraph system at Wilmington, Del., 470 B-3 Chloride cells, 6 ampere-hours capacity are used. They are divided into 22 separate units, of from 7 to 30 cells each; each of the 11 units having a battery in duplicate. Current at 119 volts pressure passes through a knife switch, a fuse, a polar and neutral relay, and finally through lamps and resistance coils to the six charging sets; the lamps and resistance coils varying with the cells in circuit. In case of reversed polarity, the armature of the polar relay falls on the back stop, thus completing a circuit through a bell, which rings until the polarity is corrected. If the dynamo should stop, the neutral relay opens, and the circuit is broken, thus preventing batteries from discharging through the generator circuit.

In the Baltimore office of the Chesapeake and Potomac Telephone Co., the outfit consists of two portable 4-volt batteries. The sets are used alternately, and are carried by two men a distance of three squares for charging. Notwithstanding the provision of a duplicate set, and the trouble of carrying batteries, far more satis-

factory results have been obtained than with the primary battery of 80 cells, which was formerly employed.

Many have contended that the first cost and the maintenance charge for storage batteries are so great as to prohibit them from all use in private plants. That this idea is a fallacious one may be readily seen by any one who will take the trouble to look up the cost and details of a few of the many private plants now in existence.

In a plant in New South Wales, the total cost of working is \$35, not including the attendant's time, who in this case is the gardener. The total cost of installation of everything except the building was \$1000. The plant consists of an oil engine, dynamo, and battery of sufficient size to light 25 lamps two days in winter, or three in summer. In a French plant consisting of a 0.75-H.P. gas-engine and dynamo, and a battery of 85 available ampere-hours, with an installation of 25 lamps, the total cost was only \$440.

For a small gas-engine plant, using accumulators, the cost, as estimated, is:<sup>1</sup> Building, \$2420; engine and 20 kw. dynamo (110 volts), \$7500; 62 cells, 572-ampere-hours capacity, \$4000; total, including switchboard accessories, cranes, tools, etc., \$15,000. For the running cost, 750 lamps are assumed for 900 hours per year; also that 40% of the total energy is delivered by the accumulators; 5% of the first cost is allowed for their maintenance. With this as a basis, it is calculated that from 12.9% to 17.1% of the capital invested will be earned per year according to the price for gas. With

<sup>1</sup> *Elektrotechnischer Anzeiger*, Nov. 29, 1894.

the direct system, a 500-H.P. plant will cost about \$47,000; with a storage-battery system, about \$46,000, the battery representing \$22,500, and the steam plant being just half the former size. The average cost, according to the quotations from leading battery-makers, for a battery to give 1 kw. for 3 hours, will be \$65, or including switchboard, instruments, building, etc., \$95. A 1-kw. steam plant will also cost about \$95, but if everything is considered, foundations, flues, chimney stocks, etc., the cost will be in favor of the accumulator plant.

Among the more pretentious private plants may be mentioned that at Ellerslie, the home of ex-Vice-President Levi P. Morton, which comprises a 35-H.P. steam engine, two C. and C. generators, of 12.5 and 25 kw. respectively, and 67 G-11 Chloride cells. That of Mrs. Hearst, at Sunol, Cal., comprises a twin-cylinder gasoline engine of 22 brake H.P., a generator, and 60 F-11 Chloride cells. That in Mr. Charles T. Yerkes' New York residence is probably the largest private plant in existence. In this installation is a 35 actual H.P. Otto gas-engine, belted to a 30-kw. Siemens-Halske generator—shunt-wound—and a battery of 60 G-25 Chloride cells, 2500-ampere-hours capacity at a 10-hour rate. The maximum discharge is 2000 ampere-hours at a 4-hour rate. A 7.5-kw. 4-pole "booster" is also provided.

During the erection of a large music hall in Zurich, Switzerland, which required an installation equivalent to 2000 16-C.P. incandescent lamps, it was found that the night load at the central station, an alternating-

current station, had nearly reached its full capacity, that the mains carried their full load, and that the day load at the station was comparatively small. It was decided, therefore, to install accumulators, which were to be charged during the day, and carry the full music-hall load at night. As only that portion of an alternating-current wave can be utilized in charging in which the voltage is higher than that of the battery, two improved Pollak rectifiers were installed, by which the regulation of the precise point of the wave could be obtained by simply moving the brushes. Two batteries of accumulators, in all 113 cells, of the Pollak type were connected to the two sides of the three-wire system; the capacity of the battery being 1528 ampere-hours at a 4-hour rate. Current is supplied through two transformers of 30 kw., and two auxiliary transformers of 15 kw., connected in series with the others, thus adding their 55 volts to the 105 volts of the larger transformers. The auxiliary transformers have ten contacts on different parts of the coil, by means of which the voltage is controlled. Excellent regulation is obtained, the brushes on the rectifier being seldom moved, and the efficiency of rectification has been found to be about 94%. Mr. Pollak claims that such a rectified current has the peculiar property of accelerating electrolytic processes; which property has not yet been satisfactorily explained.

A novel scheme has been proposed in France, which, if successful, will open up a comparatively new field for accumulators. This is to furnish all towns along or near the river front with a storage-battery plant, and

then to charge these batteries successively by means of a floating central station. By this means many towns, too small to have a complete installation of their own, may be furnished with electric power with but few of the attendant expenses.

In a paper read by Mr. B. J. Arnold before the Northwestern Electrical Association, in St. Paul, Minn., the following interesting table of data was given.

	DIRECT CURRENT		D. C. WITH ACCUMULATORS			ALT. C.
	Eberfeld	Hamburg	Barmen	Hanover	Düsseldorf	Cologne
Available power in kw. . .	500	580	225	600	600	680
Expenditure in dollars per kw. . . . .	545.53	816.93	908.50	785.70	926.35	693.55
Duration of working in years . . . . .	5	4	5	2	1	1
Profit, % capital . . . . .	14.09	18.05	7.65	11.34	7	7.2
Total energy in kw. hr. distributed . . . . .	305,794	513,183	122,026	316,114	337,285	307,074
Energy per pound of coal in kw. hr. distributed . . . . .	.....	140	90	181	129	71
Cost per kw. hr. in cents distributed . . . . .	5.70	5.18	6.85	5.02	4.54	6.65
Power utilized divided by power available in % . . . . .	80	79	61	48	51	50
<i>Use of Accumulators</i>						
Energy expended for charge in kw. hr. . . . .	.....	.....	59,573	194,733	279,506	.....
Energy furnished by discharge in kw. hr. . . . .	.....	.....	42,584	154,836	216,561	.....
Industrial efficiency of accumulators in % . . . . .	.....	.....	71.5	79.4	77.5	.....
Loss in accumulators in % of total energy distributed . . . . .	.....	.....	14	11	13	.....

At the station in Kijew, Germany, employing 72 E.P.S. accumulators, a current efficiency of 83% and an energy efficiency of 68% is reported, for the three years ending November, 1894. At Cassel, England, for

1895, the energy efficiency was 72.5%, and the current efficiency 85.3%. At the Clichy Sector, in Paris, two sets of batteries of 250 cells each have been installed, with a capacity of 2000 ampere-hours at an 8-hour rate; one set of batteries are of the Chloride type, and the other set, the Tudor. For the five months ending July, 1896, the mean efficiency was 69%, the mean daily output was 75% of the total capacity at the normal rate, and the minimum daily output, 70% of the total capacity at the normal rate. At Düsseldorf, for 1894 and 1895, the average output for one year was 56.5% of the total output, the total output being 3,650,730 ampere-hours. The following table gives the monthly efficiencies for the same station.

April . . . . .	64.7%	October . . . . .	52.7%
May . . . . .	78.0	November . . . . .	48.3
June . . . . .	82.2	December . . . . .	44.9
July . . . . .	73.8	January . . . . .	48.4
August . . . . .	80.7	February . . . . .	54.6
September . . . . .	72.2	March . . . . .	56.8

On the Zurich-Hirslanden railway, the introduction of accumulators has effected a saving of 2.2 pounds of coal per hour, or about \$2500 per year. The coal consumption on this road is from 30% to 40% less than on a similar road where storage batteries are not used. In Belfast the total efficiency of the station is 91%, and the battery loss, 6.7% of the total energy generated; the total generating expenses are 6.48 cents per kilowatt-hour sold. In Edinburgh the total expenses are 3.12 cents per kilowatt-hour sold.

At present, in installing a storage-battery plant, the

battery should be about one-third the maximum full-load capacity of the station. Figs. 108 and 109 show the per cent maximum demand factor, and the per cent load-factor, for some English central stations, both with and without storage-battery equipments. It may not come amiss to state that the load factor indicates to

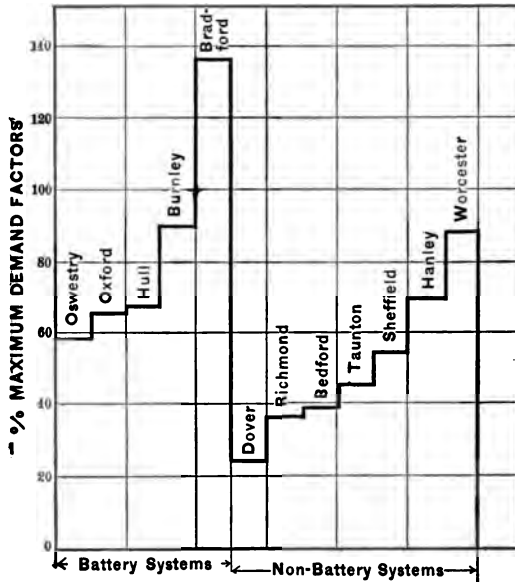

FIG. 108.

what extent the hours have been filled up by work, and the maximum demand factor assists in showing what there is superfluous in the generating plant. In a battery station, the maximum demand factor may, of course, exceed 100%, as is the case in Bradford; but in a non-battery station, never, unless its rated capacity is lower than its real capacity.



In conclusion, it may be stated as a fact that in all stations that have to meet a fluctuating demand, a combined accumulator and steam plant will be found cheaper in first cost, and cheaper and far more satisfactory in

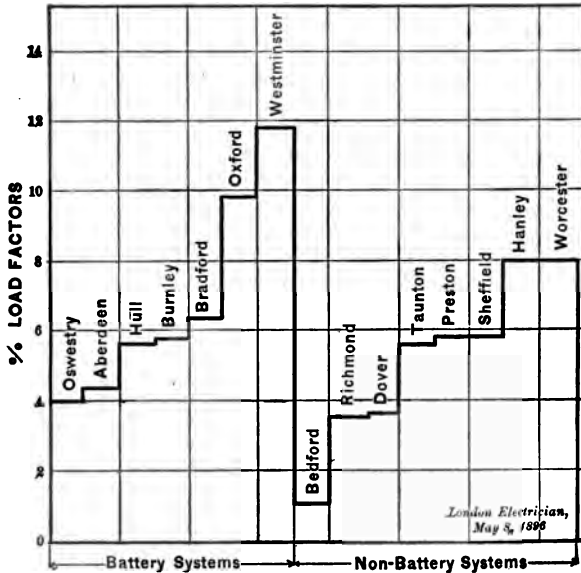

FIG. 109.

running, than would be a steam plant alone for the same work. Also that with all railways, whenever more than fifteen cars are to be provided for, it will be economy to use accumulators. The same statement holds wherever water power is to be employed in direct-current systems.

## CHAPTER VIII

### APPLICATIONS — TRACTION

STORAGE-BATTERY traction is, naturally, the most desirable method of traction in existence. The hope of being able to do away with the unsightly overhead fixtures, or the undesirable and costly conduit system, and of having each car its own unit, led many investigators to experiment with accumulators for traction purposes. Experiments tending to this end were carried out as early as 1880, and in 1881, at the Paris Exposition, two cars were put into practical operation, with a fair degree of success. In 1883 another car was put into operation at Kew Bridge, London. This car was equipped with a Siemens generator, used as a motor, and under the seats were placed 50 cells of about 4000 pounds, total weight. The car carried 50 passengers, and attained a speed of about 6 miles an hour, on a level track. It is said to have run very smoothly.

The success of these two experimental roads encouraged the other investigators, and in 1885 and 1886, two roads were started, one at Antwerp, and the other in New York.<sup>1</sup> Roads were also started in London, Paris, and Brussels. The cells carried were capable of running the cars from 35 to 50 miles on one charge,

<sup>1</sup> The New York road was constructed by the Julien Electric Co.

and weighed anywhere from 2000 to 5000 pounds. A number of companies have taken up the subject in this country, and several experiments on a commercial scale have been conducted in New York, New Orleans, Washington, Philadelphia, Dubuque, and Baltimore. These experiments have not, however, been commercially successful, and have, without an exception, been abandoned, so that not a single road is, to-day (in 1897), commercially operated by storage batteries in this country, *i.e.* is operated independently of the storage-battery companies, unless we except the Chicago and Englewood Accumulator line, and the single storage-battery car operated by the Washington Park and Spring Grove Railway Co., at Sioux City, Iowa. It is impossible to draw commercial conclusions from the reports of cars that are under the continual supervision of electrical experts, employed by the installing rather than by the operating company.

In Europe, on the other hand, accumulator traction has a decidedly better outlook, there being 12 lines, distributed as follows: 1 each in Austria, England, and Holland; 4 in Germany and 5 in France. Besides this, Germany has two other lines, the Hanover and Dresden lines, run on the combined accumulator and trolley system.

Mr. A. H. Gibbings<sup>1</sup> in a paper on Accumulator Traction gives a number of disadvantages attendant upon overhead and conduit systems, which do not occur where accumulators are used.

<sup>1</sup> London Electrician, Vol. 34, p. 252.

1. Irregular demands upon the generating plant. The station must be ready to supply, at any time, every possible demand upon it.

2. A greater wear and tear of the machinery.

3. A greater expense in running at the station.

4. The voltage must be kept constant at all points of the line.

5. A greater original outlay of capital. For example, 250 H.P. is required to run 7 cars either by the overhead trolley or the conduit system, while for the accumulator system, at a rate of 80 cells per car for 7 cars, not more than 100 H.P. would be required. Mr. Epstein, in replying to some criticisms on Mr. Gibbings' paper, claims that, notwithstanding the greater first cost of batteries, the original outlay, in the case of accumulator traction, is yet considerably less than with other systems.

There are two other most potent factors in favor of accumulator traction; having both been proved by experience, they obtain still greater weight.

6. For the same amount of heat energy of the coal, 20% more power is applied to the axles, in the case of accumulator traction than with the trolley system.

7. The power plant required when storage batteries are used is only two-thirds of that required for a trolley road.

Mr. J. Bracken, — in a paper read before the National Electric Light Association at Niagara Falls in 1889, — in speaking of the relative costs of horse and storage-battery traction, said that it would cost \$4000 to purchase enough horses to run a 16-foot car 120 miles per

day, while it would cost \$1500 to purchase enough storage batteries to do the same work. Batteries, he claims, can be maintained and replaced for one-half what it costs to maintain horses.

Overhead wires, besides being unsightly and a source of danger from the high tension currents used, are a formidable obstruction to firemen when engaged in fighting fires. One of the greatest objections to the direct-supply system, which does not apply where storage batteries are used, is that of trouble at the power-house. When this occurs, all the cars on the line are often stopped until the trouble can be remedied. In the case of accumulator traction, there are no external circuits, and lightning is therefore less apt to play havoc with the electrical part of the equipment. Furthermore, the "grounding" of one motor does not affect others, and the durability of the motors is greatly increased by reason of the low pressure used in this system.

Although it is acknowledged by every one that storage-battery traction is the ideal system, yet at present the disadvantages so far outnumber the advantages, that the outlook for accumulators is exceedingly gloomy. Perhaps the greatest argument against them, although decried by the supporters of storage-battery traction, is the large amount of dead weight that has to be carried. Crosby and Bell,<sup>1</sup> in treating of this subject, say:

"The experiences of a large number of electric roads, extending over a number of years, have shown that the

<sup>1</sup> The Electric Railway, Crosby and Bell, p. 245.

work required per car-mile, on ordinary 16 or 18 foot cars, is a little less than 1 horse-power-hour for ordinary grades, and at a speed of 8 to 10 miles per hour. Assuming the average car-mileage at 100, which is very nearly a mean of the roads now running, and with two changes of battery a day, the weight required would be about 4000 pounds of battery for the regular service of the car. The few cars that have been experimentally operated with the alkaline-zincate battery — carrying only 2500 pounds of battery — have not, at the time of writing, been in service long enough to permit a fair judgment of the results.”<sup>1</sup> Storage batteries have been so much improved of late years that the above objection, though still great, is less cogent than formerly. Mr. Epstein claims that the weight of a car, with the storage batteries, is only about 20% more than that of the ordinary electric car. From various reports, however, the weight is increased from 20% to 40%, — as on the new Brussels road, — the average being nearly 30%.<sup>2</sup>

On the other hand, Mr. Walker<sup>3</sup> claims that it is impossible to place sufficient accumulators on a fully loaded car to enable it to start on a wet day, if the

<sup>1</sup> The service has been abandoned but it should be remembered, in justice to the storage battery, that the prime cause for the abandonment of the service was not the fault of the battery itself, but rather the poor financial management and the large amount of litigation. Besides this, the batteries were too light to successfully cope with the work they were called on to do, and the cars were run over old and battered track, and over long and heavy grades.

<sup>2</sup> The proportion of the weight of the cells to the weight of the car, should average about 1 : 3 · 5, but for very light vehicles, may be as low as 1 : 2 · 75.

<sup>3</sup> London Elec. Review, May 11, 1894.

gradient be over 5%. Since the traction coefficient increases with the grade, it being four times as great on a 3% slope as on a level, it seems that the weight of lead accumulator, owing to its inability to discharge with sufficient rapidity, would become so great that its use would be impracticable. At the time of writing, the average efficiency of the various accumulators on the market is 3.5 watts per pound of total weight, on a 3-hour discharge, using sealed rubber jars. Mr. Sprague believes that storage batteries will never take 10 tons up a 10% grade until their weight efficiency is considerably higher than at present. According to Professor Anthony, the extra batteries which would have to be kept on hand to draw from during the "rush" hours would cost more than the plant it would save.

The greater weight of an accumulator car becomes most objectionable in the crowded portions of the city, where it is necessary to stop and start frequently. The method, therefore, of using them in combination with the trolley, the trolley to be used in the suburbs and the accumulator in the city, as in Hanover, is the reverse of the most favorable conditions for storage-battery traction. Where a few cars are to be used on a long line, the storage-battery system will probably be found to be the most economical as to cost and equipment; but where a large number of cars are to be run, the system of direct supply will be the best.

In 1894 Mr. Epstein published a table in one of the London electrical papers, giving the relative merits and costs of the three systems,—overhead trolley, under-

ground conduit, and accumulator system; his data, as far as possible, being taken from actual working. Some of his figures are as follows:<sup>1</sup>

For the track construction, including the overhead and underground work, the storage-battery systems cost \$29,000 per mile; the conduit, \$36,500 per mile; and the overhead trolley, \$31,400. This does not include the cost of feeders, for which an extended table is given, covering a number of different conditions. For car equipment and the like, using 40 passenger cars, the expense is \$5890 per car for the accumulator, and \$3550 per car for conduit and trolley roads. For the steam and electrical equipment of the plant, \$142 per ton propelled is required for an accumulator road, \$245 per ton propelled for the conduit or trolley system. These latter figures are based upon the assumption of 2.2 I.H.P. per ton of weight propelled for the three systems. For the electrical plant, 2.4 kw. are assigned for the overhead and conduit systems, and 1.5 kw. per ton propelled for the accumulator road. Mr. Epstein believes that the overhead and underground systems have an efficiency of 27%, while that for an accumulator line is 33%.

The average life of a storage battery is about 12,500 miles, and assuming as before 100 miles per day as the average car-mileage, the battery will have to be replaced, in part, every 125 days, or three times per year. From the latest reports of the storage-battery roads in Paris, it would appear that the total life of a plate is at least 60,000 car-miles for the positive and 90,000 car-miles

<sup>1</sup> London Electrical Review, Jan. 5, 1894.



for the negative, at which rate the positive plates will last for about 1 year and 8 months. On the other hand, the depreciation in the direct-supply systems is rarely more than 10%.

Dr. Louis Bell,<sup>1</sup> a few years ago, made some tests on the various systems of traction with the results given in the following table, where  $\frac{EL}{W}$  = economic ratio = the product of the commercial efficiency and the useful weight, divided by the total weight. If better batteries had been used, the economic ratio for the storage-battery systems would have been at least 0.25 instead of 0.18 as obtained. Some tests on an Antwerp road gave 0.29.

SYSTEM	$\frac{EL}{W}$	POWER PER UNIT OF USEFUL WORK
Direct electric . . . . .	0.385	2.62
Storage battery . . . . .	0.180	5.55
Cable . . . . .	0.500	2.00
Locomotive . . . . .	0.500	1.72

In the report of a commission on the various systems of traction by electricity, the following figures, showing the coal consumption per car-mile, were published:<sup>2</sup>

For the trolley systems at Havre, 6.03 pounds per car-mile; for the accumulator system at Paris, with the old cars, 9.2 pounds; in the new cars, where energy is stored on the down grade, 6.56 pounds; for the compressed-air line in Paris, 39.03 pounds; for the Serpollet

<sup>1</sup> London Electrician, Vol. 23, p. 609.

<sup>2</sup> Mémoires de la Société des Ingénieurs Civils, January, 1896.

steam line in Paris, 7.6 to 10.6 pounds; for the trolley system at Marseilles, 7.7 pounds, this including the lighting of the cars and the power station.

In a paper by E. A. Ziffer,<sup>1</sup> read before the International Street Railway Association at Stockholm, it was stated that in the Belpaire steam system, as used in Belgium, the coal consumption was 5.3 to 8 pounds per car-mile, and the water consumption, 7.1 gallons per car-mile. In the Thomas steam system in Saxony, the heaviest grade being  $\frac{1}{2}\%$ , the coal consumption was 7.1 pounds per car-mile; and in the Rowan steam system, used in Denmark and Germany, the coal consumption was 9.6 pounds per train-mile, the heaviest grade being 0.5%.

Probably the largest installation for the operation of storage-battery cars is in Paris, three accumulator lines having been established there in 1892. The following statistics regarding the road were taken from a paper read before the Société Internationale des Electriciens, in April, 1895, by M. Sarcia. According to this report, the cost of operation was 16.7 cents per car-mile with the old method of placing the batteries; that is, under the seats of the car. By the new method, that of placing them in a tray between the two separate trucks, the cost of operation, including maintenance, handling, motive-power, motormen, and maintenance of trucks and motors, is 11 cents per car-mile. In the new cars, also, "recuperation" is being used with very good results. The controllers are so constructed that, on descending a grade, much of the energy used in ascend-

<sup>1</sup> St. Ry. Jour., New York, Vol. 13, p. 26.

ing it is recovered. Fifty-six Laurent-Cély cells—the French Chloride battery—of 230 ampere-hours capacity are used; each cell containing 9 plates, about 8 inches square. Experience has shown that the life of the positive plates is 8700 car-miles, at the end of which time the active material begins to drop out considerably. The plates are then removed, and the active material is reintroduced in the form of a paste, after which operation the plates are nearly as good as new. By this method the minimum life of the positive plates is 60,000 car-miles, while that for the negatives is 93,000 car-miles. The positive plate contains a central core of antimonous lead (10%). This core is grooved, thus constituting a series of small receivers for the active material. The weight of the loaded car is 12.9 tons, that of the battery 1.9 tons. The coal consumption per car-mile, in 1893, was 12.9 pounds; in 1894, 9.2 pounds; and in 1895, when “recuperation” was used, 6.56 pounds. The power per car-mile at the power station is 1.12 B.T. units.

The Theryc-Oblasser accumulator has been lately tested by the French Government. It has been found that a horse-power-hour could be obtained with 48 pounds' total weight, in a volume of  $\frac{1}{3}$  of a cubic foot, and that the battery could stand a discharge of 6 amperes per pound, the average rate being 1.36 to 1.8 amperes per pound. An accumulator line has recently been completed between Nice and Cimiez using Laurent-Cély cells per car.

The Belgian Government has decided to install a storage-battery line between Brussels and Tervueren,

and the following advance data have been given out concerning the road: the road is 9 miles long; the cars, 52.5 feet long, mounted on two bogies, ready for service, weigh 42 tons, of which the battery weight is 12 tons; the motors are compound-wound, for an E.M.F. of 500 volts; the speed is to be 31 miles per hour and is to be reduced to 18.5 miles on the steepest gradients.

The Pollak system is soon to be tried experimentally in Frankfurt-on-the-Main, the batteries to be charged on the car at the end station.

Since April, 1897, accumulator traction has been in regular service at Ludwigshaven-on-the-Rhine; the mean speed being 30 miles per hour.

A line was started from Hagen to Vienna, using the Waddell-Entz cells. This line, which was running experimentally for only a short time, was found to be so successful that it was officially opened and accepted in July, 1895. The road is 1.9 miles long, the sharpest curve has a radius of 50 feet, and the steepest gradient is 4%. Each car carries under the seats 136 accumulators, of 300 ampere-hour capacity, each accumulator containing 13 plates. One charge is intended to run the car about 20 miles. The weight of the battery is about 2 tons, and the weight of the car, ready for service, about 10 tons. A test showed that a horse-power-hour could be obtained with about 90 pounds' total weight; and that the power per car-mile, required at the power station, was 1.28 B.T. units. The E.M.F. is 0.85 volt, and the energy efficiency 60%.

A report published by a traction company in Birmingham, England, a company controlling four systems,

(horse, locomotive, cable, and storage-battery), show the relative expenses, in cents per car-mile, for the year ending June, 1893.<sup>1</sup> This road, which has not paid expenses since 1891, is still continued, but it is believed a change will soon be made from the storage battery to the overhead trolley. One reason for increased expenses is the increase in wages and the price of raw material.

	HORSE	CABLE	STEAM	ELECTRIC
Gross receipts . . . . .	21.58	32.20	31.60	32.24
Total cost of traction . . . .	20.24	12.64	22.44	33.10

The following table<sup>2</sup> shows the ratio of operating expenses to receipts for five years, for the accumulator line.

YEAR ENDING JUNE	OPERATING EXPENSES ÷ TOTAL RECEIPTS	NO. CAR-MILES RUN
1891	67.13	138,396
1892	117.81	188,760
1893	102.56	140,993
1894	101.61	139,123
1895	131.21	138,925

The batteries first used on this line were of the E.P.S. type, but no data concerning them are available. The next tried were the Epstein cells, introduced in 1892. Twelve sets of 92 cells made an average of over 15,000 car-miles without removal. With these cells the cars ran

<sup>1</sup> Elec. World, New York, Vol. 22, p. 214.

<sup>2</sup> London Elec. Review, Vol. 37, p. 309.

very regularly, and under the trying conditions of a severe winter. The Epstein cells were run under a maintenance contract of 3 cents per car-mile, which amount, it is claimed, should have proved very profitable to the contractor, and might have been reduced. These batteries ran a total of 188,000 car-miles, at a total of 28 cents per car-mile. The accumulators now in use are of the Chloride type, and were installed in 1894. There are 17 batteries, each battery consisting of 72 cells. The batteries weigh from 1.75 to 2.75 tons, and are used on cars which, when filled with passengers, weigh, without batteries, about 10 tons. The batteries are considered inefficient when they refuse to do more than a 2-hour run. These batteries are not bought outright, but are rented on a basis of the car-mileage. The present contractors consider that the conditions of running on this line are very much against the financial success of accumulators. The total cost for the maintenance of batteries is less than 10% of the total cost per car-mile run.

On Jan. 7, 1896, three cars went into service on a section of a tramway between Berlin and Charlottenburg. A car with 29 passengers weighs, complete, about 11.75 tons,—the weight of the accumulators being about 3.6 tons. The cars are equipped with 124 Schaeffer-Heineman accumulators, containing five positive and five negative plates in a celluloid cell, protected by a wooden casing. Two of the cars are in constant use and the third is employed in carrying the batteries to and from the charging station, a distance of 1.4 miles from the terminal of the line. The steepest grade on the line

is 3.6%, and 1640 feet long. The battery plates are 0.117 inch thick, 13.65 inches high, and 7.8 inches long, and are separated from each other by a distance of 0.234 inch. The cars have been in regular service since Jan. 12, 1896, with most gratifying success. The consumption of energy is 4.5 kw. for a speed of 7.44 miles per hour. The battery runs regularly 67 miles per day on one charge, consuming in that time 144 ampere-hours; the car has, in fact, run 105 miles on one charge. The consumption per car-mile is 517 watt hr., which includes lighting the car with 7 16-C.P. incandescent lamps. The current is brought from a Berlin central station at about 4 cents per kilowatt-hour, the total cost of operation, on that basis, being 8 cents per car-mile.

The Brookline, Mass., Street Railway Co. are about, (1897), to install an accumulator line using Chloride batteries on a 22-foot car. According to the contract with the Electric Storage Battery Co., the latter are to operate the road for at least six months to the satisfaction of the owners, and are to pay equipment costs in case of failure.

The accumulator line in Holland, to which reference has already been made, lies between The Hague and Scheveningen. This road has 7 miles of track and runs 14 motor-cars, the maximum gradient being 1 : 50. The weight of the loaded car is about 15 tons, and the weight of the batteries 4 tons—Julien accumulators being used. The maximum distance run on one charge is 44 miles, and the positive plates remain in service, without renewal, from 9000 to 13,000 car-miles. The

cost of maintenance is 1.7 cents per car-mile, and the cost of handling 0.46 cent per car-mile.

The Madison Ave. road, in New York City, was at one time equipped with Chloride batteries. Sixty cells, containing 9 plates each, were placed in a box carried by the truck of the car. Four cars were run on this road for about three months, but the expense of running was found to be too great. On an experimental car in New York City, using the Acme battery, the average energy required per car was 1.07 horse-power-hours. This car ran from September, 1892, to December, 1893.

The Chicago-Englewood line, which has a franchise for 54 miles of railroad, is expected to be in complete operation very shortly. This, the company claims, is the first real attempt to operate a storage-battery street railway under conditions that are in every way favorable to success. To begin with, the power plant is of the most modern type. The units are connected according to the Arnold system, and will be operated at an approximately constant load. Three potentials will be used in charging, — 150, 170, and 190 volts, — and in this way all unnecessary loss in rheostats, or counter E.M.F. cells, will be obviated. The track will be laid with 80-pound girder rails, and will be ballasted with stone. The road-bed is practically level. Forty cars will be run, each car containing 72 Chloride cells, of 4 tons' total weight. These cells will be capable of delivering 400 amperes at 150 volts, and will be contained in a tray mounted on the truck. One 50-H.P. motor will be used. The company expects to be able to change the batteries in three minutes.



A mixed trolley and accumulator system is being tried in Hanover, Germany, the trolley being used in the suburbs and outlying portions, in all about 13.5 miles, and the accumulator in the dense and crowded portions, about 11 miles. Charging proceeds continuously where the trolley is used, the lengths varying from 1.75 to 5 miles, and discharging in lengths of road varying from 3 to 7.5 miles. A car seating 20 people and weighing, ready for service, 8.50 tons, carries 208 Tudor batteries, — weight 2.87 tons, — of 25 ampere-hours' capacity, at a 1-hour rate. The plates are placed in rubber jars, hermetically sealed. An additional lamp is cut in or out, according as the trolley or battery current is used, and another device disconnects the ground return when the battery current is to be used.

The cost of maintenance for 1896 was 0.35 cents per car-mile, including renewals. During regular work only 25% of the energy is used, the remainder being held as a reserve. With a mean of 8 charges and discharges, an efficiency of 74% was obtained. The following figures concerning the road may be of interest :

MONTH	Kw. HR.	ACC. CAR- MILES	WATTS PER POUND OF COAL	MONTH	Kw. HR.	ACC. CAR- MILES	WATTS PER POUND OF COAL
Jan.	58,590	5,973	706	July	107,970	31,479	1030
Feb.	55,337	5,504	715	Aug.	116,856	35,026	1066
Mar.	61,633	5,931	766	Sept.	129,989	40,871	1060
Apr.	83,326	17,045	895	Oct.	136,821	46,758	1058
May	106,765	27,010	982	Nov.	161,941	65,778	1011
June	100,933	25,387	1042	Dec.	176,949	76,806	1009

The results have been so satisfactory that the company has decided to equip all but one of its lines with this system. This exception is to be operated entirely by storage batteries. The Dresden Tramway Co. have likewise decided in favor of the mixed system. The proposed electric railways in Ghent, Belgium, will also use the mixed system.

A report from the road in Dubuque, which has recently been closed, gave the total motive power expenses as 7.8 cents per car-mile, of which the battery expenses, including shifting, cleaning, maintenance, etc., was 5.29 cents per car-mile.

Mr. Manville, in discussing the relative merits of trolley and accumulator traction, states that the cost of running on the English accumulator lines exceeds 18 cents per car-mile, while that for the overhead trolley lines is only 9 cents per car-mile. Although many companies claim to be able to maintain the batteries for 3 cents per car-mile with profit, the majority of the reports that have been received from roads in actual operation, indicate that the cost of maintenance is nearer 5 cents per car-mile; [that for the Julien accumulator line, lately operated in New York City, was 5.3 cents per car-mile. The cost of operation, including the operating force, the battery men, the repair-shop force, coal, oil, waste, water, renewals, and depreciation, was 9.32 cents per car-mile.] The experience in Brussels has been that the cost of storage-battery traction is greater than with horses. It may be stated as a fact, that at the time of writing, the best efficiency of storage batteries

is from 1.1 to 1.2 kw. hr. per car-mile, on a fairly level track.

From a paper by F. S. Badger, on the cost of construction and operation of electric railways, the average cost of power per car-mile for twenty-two trolley roads, running from 3 to 140 cars each, and having a length of track of from 3 to 51 miles per road, was 1.96 cents, and the average maintenance cost of rolling stock was 1.8 cents per car-mile. The complete cost of line equipment with underground feeders, not including the road-bed, is about \$12,000 per mile of single track. On the other hand, the cost of storage batteries is about \$3800 per car. It is well known that the total maintenance cost of power plant, rolling stock, and battery is at least 1.3 cents per car-mile more than with the direct systems; but the smaller interest charges, and less cost of power, should be considered. This, it is probable, will balance the extra cost.

The experiments made by M. Sarcia<sup>1</sup> on a St. Denis car show plainly the value, from a financial standpoint, of "recuperation." As before stated, by recuperation is meant the recovery of energy on the down grades and the charging of the batteries with it. These experiments cover a period of 100 trips, during which all the energy used was measured, as also that which was recovered. The motors were separately excited, and had an adjustable resistance in the field circuit; the armature resistance being only used for obtaining a more gradual start. By the adjustment of the field resistance, therefore, the voltage of the motor, when running

<sup>1</sup> L'Industrie Electrique, Dec. 10, 1895.

as a generator, could be easily controlled. For the coefficient of traction he uses that measured at the terminals of the motor, including therefore all subsequent losses. Outside of Paris the Vignole rails are used, and in the city itself the Broca rail. The coefficient of traction varies from 16.72 pounds per ton on the Vignole rail to 34.54 pounds on the Broca rail.

With a traction coefficient of 22 pounds per ton on a level track, and a grade of 10%, he found that 57% of the energy spent in mounting was recovered. With the same traction coefficient 42% was recovered on a 4% grade, 23% on a 2% grade, and zero on a 1% grade. With a traction coefficient of 11 pounds per ton, he found that 23% of the energy was recovered on a 1% grade, a result which shows the importance of reducing the traction coefficient to as small a value as possible.

Besides this, it should be pointed out that, while a carefully laid and substantial track is necessary in every system, on an accumulator line it is doubly so; for not only do the irregularities of a rough track and the consequent jolting injure the accumulators, but the heavier cars pound the track in a very serious manner. In building a storage-battery road it would be well to follow the example given by the Chicago-Englewood line.

In the light of these reports one is driven to the conclusion that not only is storage-battery traction more expensive than other systems of electric traction, but that unless the batteries are considerably improved it is likely to remain so.

In devising cells for traction purposes, many difficulties arise. Owing to the heavy first cost and the increased weight, the number of cells must be as small as possible, and they must be so constructed that their weight efficiency is high, their internal resistance low, and their capacity large. The metal grids must be strong enough to withstand the jolting and the oscillation, and they should be so constructed that the active material will not fall out. The employment of distance pieces tends to reduce the space needed for the electrolyte, and should therefore be avoided as much as possible. Durability and a high rate of discharge are naturally the main requirements of a good traction battery. In order to obtain these, it is necessary that the conducting space should be protected from local action. Many investigators believe, and practice has proven their views to be correct, that the forming should proceed from without inwards; and that the discharge should never, under any circumstances, be allowed to reach the support plate.

Fitzgerald believes that the reason such poor results have been attained heretofore is that the present style of accumulator is not adapted to the conditions of traffic. Besides this, the weight of the electrolyte used is far in excess of what is required. The *London Electrician*, in an editorial on Dec. 13, 1895, says: "It is probable that the electrical industry has yet to produce a battery which is commercially adapted to the conditions of traffic, and its non-existence is one of the most serious hindrances to electrical progress, possibly the most serious of all. Although a

real commercial traction battery cannot be said to exist, we do not care to assert that the outlook is hopeless.”

According to Fitzgerald,<sup>1</sup> a cell should be rejected for traction purposes unless, after a trial of one month, it complies with the following conditions :

1. The mean ratio of power to gross weight should attain, and should not exceed, 1.2 watts per pound.

2. The weight of an accumulator per ton of traction weight should not exceed 321 pounds, and this should be able to supply 385 watts as an average for the whole run ; he prefers to take 1.35 watts per pound as a minimum value.

3. The mean ratio of discharge for the whole run should attain 0.58 ampere per pound.

“Until definite reports are received,” in the words of Crosby and Bell, “one is not justified in counting too much on the hopeful results of the preliminary experiments. An approximate statement from the Dubuque road gave 1.5 horse-power-hours as the output required per car-mile from the station. This figure affords a basis for a rough comparison with the trolley system. The average station output in the latter case is 1 horse-power-hour per car-mile. Remembering that on account of the greater weight of an accumulator car about a third more power is required to propel it, the relative efficiencies of the two systems are shown to be not far from those deduced elsewhere.”<sup>2</sup>

These figures give 40% for an accumulator road, and a little less than 50% for a system of direct supply.

<sup>1</sup> London Elec. Review, April 3, 1895.

<sup>2</sup> The Elec. Railway, Crosby & Bell, 2d ed., p. 252.

As regards electric vehicles, the conditions are so different, that batteries may be designed with a more exact knowledge of the demands that will be put upon them. That this is so is proven by the fact that electric carriages are coming more and more into popular favor, nearly every carriage-maker of prominence having made arrangements for building such carriages. M. Claude, in *L'Industrie Electrique*, for Oct. 10, 1897, gives the following equation for electric carriages, where  $M$  represents the weight of the carriage in kilogrammes;  $y$ , that of the battery;  $x$ , their specific energy in watt-hours per kilogramme; and  $k$ , the mean specific energy required per day for traction,  $k$  being expressed in watt-hours per kilogramme of total weight.

$$k(M + y) = xy.$$

Hospitalier has figured that a mean of 100 effective watt-hours per ton kilometre is required in a pneumatic-tired, ball-bearing carriage, and Messrs. Salom and Morris and others have arrived at the same conclusion. Both theory and practice agree that the weight of the battery should vary between the limits of 25% and 50% of the total weight. If lower than 25%, the distance which the carriage may cover on one charge will be too small, and if larger than 50%, the useful weight, that is, the weight allowed for passengers, will be too small, and the difficulties in the construction of a light carriage will be enormously increased. The usual practice is to make the accumulator weight about 35% of the total, which corresponds to a speed of about 11 miles per hour on a level road. M. Claude estimates

that the total cost per day per carriage is about \$1.63, while the corresponding cost for animal traction is \$3.09; Bixio has figured that animal traction costs \$130 per carriage per year, petroleum traction \$106 per carriage per year, and electric traction \$96 per carriage per year. Practice has already shown the electric carriage to be more economical, and that it gives better service than any other system in existence.



## CHAPTER IX

### CONCLUSIONS

WHEN charging accumulators, care must be taken not to use too high a current density. It is evident from what has been said regarding the theory of accumulators, that the internal resistance of a cell will be highest immediately after discharge. Too large a charging current, therefore, will evolve heat, thus wasting energy. There will also be another loss by a too copious evolution of gas. On the other hand, too low a charging rate will be found to be as bad as one that is too high, since it tends to produce the white sulphate on the positive plate, instead of the peroxide. Gladstone and Tribe discovered this fact, and note it in their book:<sup>1</sup> "If we take two plates of lead in dilute sulphuric acid, and pass a current from only one Grove cell, a film of white sulphate, instead of peroxide, makes its appearance on the positive plate, and the action practically ceases very soon. If, however, the current is increased in strength, the sulphate disappears, and peroxide is found in its place." It is usually found that a lower rate than one-thirtieth of the normal capacity of the cell is detrimental.

<sup>1</sup> Chemistry of Secondary Batteries, p. 11.

When the charging current is too large for the area of the plate, "buckling" will ensue, and soon after, short-circuiting will take place. "Buckling" has been found to be due to the unequal expansion of the plates. The paste expands on discharge, and *vice versa*, and it is imperative that such expansion and contraction should be uniform over the entire surface. In other cases, where the current is not large enough to cause "buckling," but still too large for the active area of the plate, "boiling" ensues, due to the energy of the current being wasted in the decomposition of the electrolyte, instead of being used in the formation of peroxide.

Many rules have been formulated as to the best rate of charge. Mr. J. D. Dallas believes that if the total area of the positive plates, taken in square inches, be divided by 20, the result will give the most economical charging rate. Messrs. Gladstone and Tribe found that a charging rate of 6.5 milliamperes per square centimetre, calculated on the original surface of the plates, was the best: this corresponds to nearly 6 amperes per square foot. The plates have, however, been improved so much since then, that 8 amperes per square foot is now the usual rate. Sir David Salomons<sup>1</sup> has formulated the following very convenient rule for calculating the best charging current. "Multiply the total number of plates in a section by 2. The result will be the best charging current for that section." He also found that the injurious current for a section, that is, the minimum current to be used, may be taken as the number of plates in a section divided by 10. The

<sup>1</sup> Elec. Light Installations, Vol. 1, p. 98.

E.M.F. of the charging current at starting should, under ordinary circumstances, be about 5% higher than the normal E.M.F. of the battery. When, however, the battery has been overdischarged to a great extent, the difference in pressure should not exceed 2%, otherwise too large a current will flow.

It is held by many that the best method for charging is to use a constant voltage. They claim as the advantages:

1. Less wear and tear of plates.
2. More rapid charging in the initial stage.
3. Suppression of a too rapid formation of gas, and consequently better conservation of the electrodes, prevention of overcharging, and subsequent useless work.
4. Reduced voltage of dynamo.
5. Less supervision required.

It has been found that when charging at 2.3 volts per cell, 50% of the total energy is stored during the first hour, 75% at the end of the second hour, and 83% at the end of the third hour.

On the other hand, it is held that this method involves a greater first cost, and consequently greater interest charges, and that the decreased voltage of the dynamo is more than compensated for by the increased amperage required.

Figs. 110 and 111 show the relative values of the two methods of charging, — at constant current or at constant voltage. They are both taken from a Gadot cell, containing 9.35 kilogrammes of plates. In Fig. 110 the battery was charged at a constant current

of 10 amperes, nearly 1 ampere per kilogramme of plate, and in Fig. 111, at a constant potential difference of 2.23 volts. It will be seen that at the end of three hours, with a constant potential difference, all but 17% of the capacity had been obtained, while to obtain this same capacity with a constant current required 7 hours.

In some cases the only current to be obtained for the charging of batteries is the alternating current. In

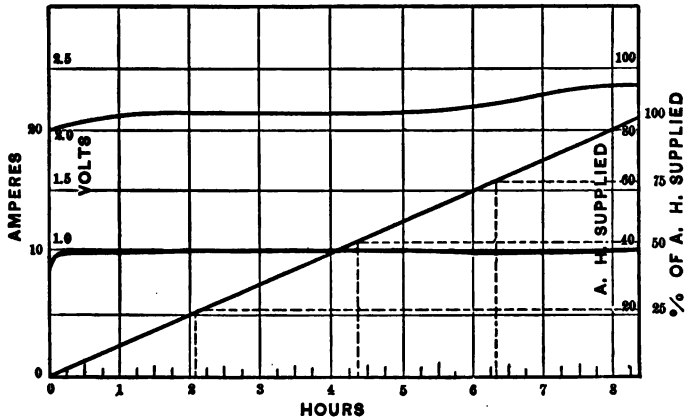

FIG. 110.

such cases, a machine called a rectifier must be used for changing the alternating to a uni-directional current. By means of this machine, only that portion of the current wave is utilized in which the voltage is higher than that in the battery. It is claimed that such a rectified alternating current has the peculiar property of accelerating electrolytic processes, and is, therefore, peculiarly adapted for charging purposes. It has not yet, however, been made clear that such rectified cur-

rents really have this property. A central station in Zurich, Switzerland, has had occasion to make use of such a machine, with gratifying results.<sup>1</sup>

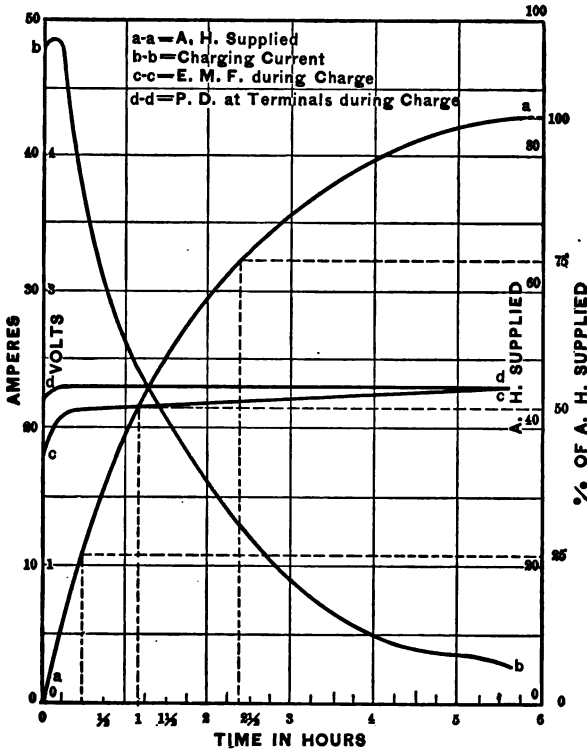

FIG. III.

When a cell has been discharged below a certain point, the excessive loss of conductivity, owing to too large a proportion of the active material having been converted into sulphate, will be apt to injure it, and the

<sup>1</sup> Vide page 192.

contact between the peroxide and the support plate may be broken. The recharging of such an exhausted cell, when, indeed, it is possible to recharge it at all, must be carried on very slowly. It should be recharged as soon as practicable, since the cell is in a weak state, and is the seat of slow reactions, in the nature of those occurring during discharge. When it is possible to recharge an exhausted cell, the current used should be at least 30% below the maximum charging rate. Care should be taken that the scale, or powder, which falls off does not stick between the plates. If it were not for the fact that the adherence of the white sulphate to the peroxide beneath, in an exhausted cell, is very weak, it is probable that the recharging of a battery, when in such condition, would be impossible.

Herr Brüggeman has concluded from some investigations he has made that the charging should be stopped at the beginning of the sharp bend of the curve; since before that point is reached the energy lost by the evolution of gas is very small, while after that it becomes very great. This corresponds to Solomon's rule, that every cell should boil in an equal degree when charging is stopped. It should be borne in mind that this rule refers only to the regular chargings, and not to the first or forming charge. In the latter case the charge should be continued for at least 30 consecutive hours, without interruption. If, however, such a run be impossible, it should be continued for at least 10 hours a day, for 3 consecutive days; the former method being preferable. When the evolution of gas becomes excessive, which will occur toward

the end of the charge, it is well to decrease the charging current.

With the pasted type of plate, the question of the duration of the first charge is far more vital than with the Planté type; since, with the former, there is great danger of a coating of sulphate being formed between the active material and the grid; especially if the plates are allowed to stand in the acid before charging, or if the charging current be stopped before the active material be thoroughly formed. If this coating of sulphate be once formed, it is almost impossible to get the plate in first-class condition, as the sulphates insulate the active material from the grid, and thus cause the action to take place on the grid itself, instead of in the active material. This applies to the positive plate, rather than to the negative, since it is easier to reduce the sulphate to spongy lead than it is to oxidize it.

The term "boiling" does not indicate the rise in temperature of a battery, but rather the great evolution of gas which occurs when a cell is nearly charged. It is evident that as charging proceeds the amount of sulphate to be converted into peroxide becomes less and less, and the plates therefore become virtually smaller, so that the current becomes too large for the work demanded of it. The result is that that part of the current not actually used in the formation of peroxide decomposes the electrolyte into its constituent elements. It will be noticed that when an accumulator has been in use for a considerable time, the gases evolved do not produce such a milky appearance of the liquid as before. The reason for this is that the plates are better

formed; consequently a larger charging current can be used without producing "boiling."

The color of the positive plates should be, when formed, of a dark red or chocolate, but when fully charged their color will be much darker, resembling more that of a wet slate; the negatives, although also of a slatish color, are always considerably lighter than the positives. To one who has become accustomed to studying the plates, it is a comparatively simple matter to tell the relative amount of charge that a cell may contain.

In using an accumulator care should be taken that, at the close of the discharge, at least 25% of the total capacity of the cell remains unused. The best modern practice is to leave 30%. In other words, the voltage of the cell at the close of the discharge should be never lower than about 1.8 volts, under load. All manufacturers indicate the point at which the discharge should be stopped, and the battery should be run in accordance with their directions. Mr. Griscom<sup>1</sup> gives the following reasons why it is undesirable to run a battery lower than about 1.8 volts.

"It should be understood that a full discharge, *i.e.* a discharge to a point situated at the beginning of the steep part of the voltage curve, is working a battery to the danger limit, and is undesirable for the following reasons:

- "1. Regulation is troublesome.
- "2. The efficiency is low.
- "3. Dangerous molecular changes take place, as indi-

<sup>1</sup> Trans. A. I. E. E., Vol. 11, p. 302.



cated by the changes in the internal resistance and in the E.M.F., as well as by "buckling."

"4. Uneven plates discharge into one another after the circuit is interrupted.

"5. The life of the battery is shortened.

"By classifying the failures and successes of a number of observations made on various batteries, the truth dawned upon us that whenever a battery was exhausted to its full capacity daily, its life did not exceed 500 charges; but whenever it was worked within two-thirds of its capacity, complaints were unknown. It is only necessary for the engineer to remember to add 50% of the capacity, as a factor of safety, to the maximum load, just as he allows several hundred per cent in calculating the strength of a bridge or axle.

"This additional amount is not a dead loss in investment. It produces many countervailing advantages. It provides a very effective and safe reserve for cases where the charging breaks down, and it increases the actual efficiency of the battery, which rises from about 80% to nearly 90%, when used with sufficient reserve. And for cases where it is necessary to maintain a constant potential difference, it raises the efficiency much more, because in these cases the commercial efficiency must be rated, not from the average point of E.M.F., but from the lowest point to which the battery falls on discharge, and when used in this way the potential difference drops only 2.5%."

When the plates of a cell are discharged beyond the maximum discharge permitted, nearly all the material of the positives becomes lead sulphate, which is soon

decomposed into the higher sulphates, which ruin the plates and cause them to "buckle" while charging.

A series of experiments has been lately conducted with various batteries to determine in what manner they are affected by heavy discharges. The conclusion which has been drawn from the work is that there is no objection, as a rule, to short high discharges, as long as the maximum rate is not affected. It is the prolonged discharge which is especially injurious to a battery, since the sulphating, which then takes place, is the cause of "buckling," especially when the discharge is not immediately followed by a charge. If, however, the discharge is too large, it is likely to drive the paste out of the plates. It is the quantity of gas which is driven from the plates at the moment of sudden heavy discharges that causes the injury. Although all makers give the best rates of discharge for their plates, it may be well to state, as an approximate rule, that a good rate of discharge is about 8 amperes per square foot of positive plate. It is on this point—that of being able to withstand heavy discharges—that the superiority of the Planté type of plates depend. A plate having a large surface, covered with a thin layer of peroxide, freely exposed to the action of the electrolyte, will be found to have a far greater capacity per pound of plate, for rapid discharging, than is the case with a plate having a thicker layer of active material. The capacity of such a cell will evidently be but little affected by the rate, and the watt-efficiency will not be nearly so much affected by the dilution of the electrolyte in the immediate neighborhood of the active material. Fig. 112,

which was taken from a Chloride plate, shows the variation in capacity at different rates of discharge.

In testing a cell, care should be taken that the source of current be steady. A battery of cells in multiple series will be found best, or, if that be not convenient, a source of current of considerably higher voltage and

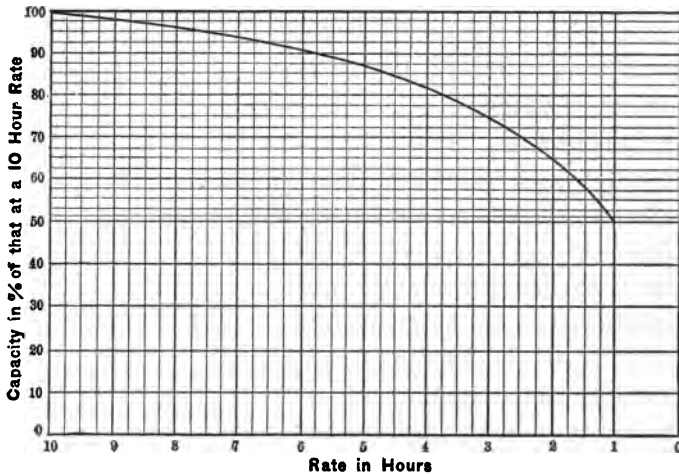

FIG. 112.

a large resistance in series with each cell will be found to give equally good results. The time interval should be so arranged that about twenty readings may be taken. The record should contain a column each for the time, volts, amperes, ampere-hours, watt-hours, and remarks, in which the specific gravity, temperature, "gassing," etc., should be noted. The specific gravity should be measured at regular intervals, say about ten times during the test. Three efficiencies should be calculated,—the volt-, the ampere-, and the watt-efficiency.

In plotting the curves, it would be well to make the horizontal or time distances small, and the vertical scale units large.

In comparing cells of different types, sizes, or voltages,—especially where the weight is an important factor,—the vertical scale should be made watts per pound rather than volts. A very useful curve for general practice is the “straight-line curve” proposed by Carl Hering in the *Electrical World*. In this, the ordinates are the capacities in watt-hours, and the abscissæ, the rates in watts. In obtaining the data for this curve, the cell should be fully charged for each test, and the discharge should be continued until the E.M.F. has fallen—in each case—a certain fixed percentage of what it stood a few minutes after the beginning of the discharge; the discharge being at a constant current. As the result is different for different makes of accumulators, each manufacturer will have to determine whether this relation approximates sufficiently close to a straight-line function for the calculations occurring in practice. When this curve does approximate sufficiently to a straight line, it will be of the general form

$$\text{watt-hours} = a - b \text{ watts,}$$

$a$  and  $b$  being constants to be determined for each particular type. By making the abscissæ the time in hours, the curve will resemble in general outline the shape of a magnetization curve. The more nearly this curve approaches to being a horizontal straight line, the more perfect (so far as the dependence of the capacity on the rate is concerned) is the accumulator.

Although in practice accumulators may be discharged discontinuously, for testing, the charging and discharging periods should be continuous, without any intervals of rest. The most rational way to charge is to charge at a constant voltage. This means using a diminishing current, and as this will be found to be a difficult matter, it is better to use a constant current until the voltage shows signs of rising appreciably, then to reduce the current suddenly to a lower value — taking voltage reading for both values — and so on to the end of the charge. M. Simon advises using a constant power, that is, a diminishing current and an increasing voltage, the rates being such that the product is always constant. He argues that charging at a constant current has the objection of taking too long, the current being weak at the beginning and too strong at the end. With a constant potential, on the other hand, the charge is almost too great at first, and so small at the end that it prolongs the time of charging considerably. A battery, in the latter case, receives, in two or three hours, more than three-quarters of its capacity. The discharge should be made under conditions of constant current, using a rheostat, stepping down by small increments for the purpose. If this is impracticable, the next best method is to discharge through a constant resistance. Where the tests are wanted for power purposes, it would be best to discharge at a constant wattage. All tests should be repeated until at least two like discharges, under the same conditions, are obtained.

In the installation of a battery, the first point to be considered is the selection of a room. This should

be dry, well-ventilated, and of a moderate temperature; otherwise the evaporation will be found to be very large. The floor must be of some acid-proof material, and so made as to drain rapidly; an outlet being provided for the liquid. If the floor is already put in, and of wood, it should be covered, especially where the battery stands, with a lead tray. The room should be located as near the generating room as possible, so as to reduce the wiring cost to a minimum.

The battery should be placed in as few tiers as possible, and in such a manner that the direct rays of the sun are not allowed to fall upon the cells. The rays of the sun are likely to crack the glass. This is probably due to the unequal expansion of the glass, for it has been found that jars which are carefully annealed never crack in this manner. Of course, the latter precaution does not apply to large batteries, where lead-lined wooden tanks or solid lead boxes are used. All exposed metal work should be protected with an acid-proof paint.

When a battery is received, the elements and containing-cells should be carefully unpacked, and all dust and any foreign particles removed. One should be sure that all insulators and distance pieces are in position, and that the plates are in their proper alignment.

In connecting the cells, sufficient sectional area should be provided; otherwise the various plates will be worked unevenly, and the full capacity of the battery will not be obtained. The most satisfactory method of connecting up is to "lead-burn" or weld the positive plates of one cell and the negative plates of the next to the same lead "bus-bar," thus ensuring good connection between

the various plates of a cell, and also between any two consecutive cells. If it is desired to solder rather than "lead-burn" the electrodes, the following method will be found to give the best results :

Strips of lead for making the joints are placed for some time in a strong potash solution, after which they are thoroughly washed and scraped. The electrodes themselves should also be scraped. The two are then held tightly in a mould, in the form of tongs, and molten lead poured around them.

If the elements are to be bolted together, one should see that all bolt connectors are thoroughly screwed up; otherwise resistance and consequent heating will result.

In setting up a battery, it should be remembered that plates deteriorate on standing exposed to the air. They should, therefore, be unpacked and set up immediately on arrival. When they are entirely connected up, they are ready for the addition of the electrolyte, and for the forming charge, which they should receive immediately.

In mixing the electrolyte, one should use only chemically pure acid, and always pour the acid into the water. Before placing the electrolyte in the cells, Lucas treats it with basic sulphide. It is then allowed to rest for 24 hours, after which it is filtered and ready for use. When filling the cells, the top of the plates should be covered with the liquid by at least half an inch, and the electrolyte should never be allowed to fall below this point.

If it is desired to separate the plates from each other, and no regular separators are at hand, perforated porous paper, saturated with paraffin wax, will be found to give

good service, and to be practically unacted upon by the acid.

When glass jars are used, it is well to paint them at the top, for about an inch, with paraffin wax to prevent the creeping of the solution.

A new battery will never give its full capacity till after about twenty discharges. During this time it should be given about 25% overcharge. After that, 10% overcharge, that is, 10% more charge than was taken out, will be sufficient for ordinary work.

In mounting cells in cars, or in any place where there is a liability of breakage, it is best to use the Boese system. In this system, a set of glass cells are inserted in a box, between which and the cells, and between the cells themselves, is poured a melted mass of some insulating material which, when cold, will be rigid, but elastic, and will retain the liquid even if the glass cells should break.

Drake and Gorham use a method for stopping the spray from an accumulator, which it would be well to adopt in all cases. This is to float particles of a light substance on the acid to the depth of about  $\frac{1}{4}$  of an inch. In all cases where it is necessary to get at the acid, this substance can be easily brushed aside. In soaking up spilled acid, many attendants use either ammonia, saw-dust, or soda; it has been found that whitening is better than any of the other remedies.

Before beginning to charge a storage battery, it should be gone over carefully, and any cell that is not up to the standard should be disconnected and put in working order before being replaced.



If the accumulators are to be used in a cold climate, it would be well to adopt the device of M. Varennes.<sup>1</sup> He places a small incandescent lamp, covered with a black varnish, in each accumulator. These lamps are connected to an automatic device which puts them in or out of circuit, according as the temperature is above or below a certain predetermined point.

In installing plants where expert attendance is not to be had, it is well to place in the circuit two magnetic cut-outs, one set for maximum current, and the other for minimum voltage, so that the battery cannot be discharged too low. It might be well, in some cases, to use a resistance instead of the regulating cells. Owing to the different lengths of time that the regulating cells have to be in circuit, it is exceedingly troublesome to keep track of them, and when neglected, their spraying becomes a disagreeable feature, all of which would be obviated by the use of resistances.

To obtain the best results in charging a battery, the following points should be watched. The rate of charge should be normal, except in cases of emergency. At such a rate, unless the constant potential method be employed, the cell may be considered full when the voltmeter reads 2.5 volts during charge. The electrolyte should be kept at uniform density throughout the cell; when water is added, because of evaporation, it should be added by means of a funnel reaching to the bottom of the cell. Care should be taken never to add acid after evaporation; otherwise the electrolyte will

<sup>1</sup> La Lumière Electrique, Jan. 6, 1894.

be too heavy. Hydrometer readings should be taken regularly; this is an excellent indication of the amount of the charge in the battery. These readings are useless, however, unless the precaution be taken to keep the electrolyte of uniform density. Fig. 113 shows the relation between the specific gravity and the capacity, and indicates clearly how close a guide hydrometer readings, when intelligently observed, are.

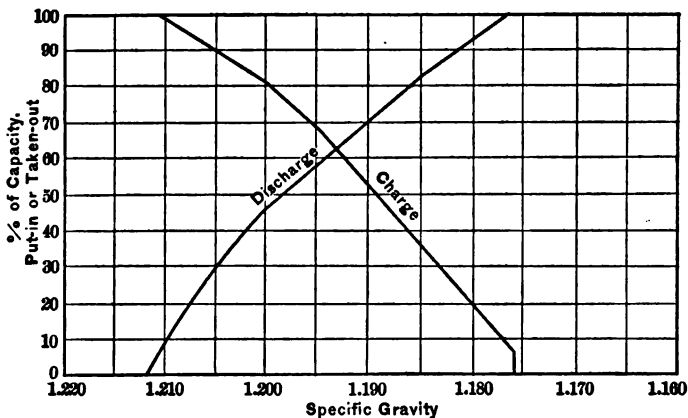

FIG. 113.

About once a week, each cell should be tested with a low reading voltmeter and hydrometer. If any cell should read low, it should be at once cut out and carefully examined to see if any material has been introduced which could short-circuit the cell. If no such trouble can be found, the cell should be disconnected from the discharge circuit and given an extra charge. If a couple of extra chargings do not bring the cell up to condition, and nothing is known concerning the cause of the trouble, the manufacturer should be consulted.

Mr. Joseph Appleton<sup>1</sup> has devised a very interesting test for determining the condition of cells. He takes a plate of cadmium, mounted in a hard rubber frame, immerses it in the electrolyte, and reads the E.M.F. between it and the positive or negative plates of the cell. The cadmium should be shaken occasionally to free it from any bubbles of gas which may be formed on its surface. The cadmium plate should be washed with water every time it is taken from the cell. "By this method," says Mr. Appleton, "it is possible to ascertain at any time during the charge or discharge whether the positive or negative plates are in proper condition or otherwise, thus locating at an early stage any sign of irregularity or trouble.

"During charge, the cadmium plate reads negative to the negative plate, until the cell is about full, when the reading should be zero; the charge should be continued until the cadmium reads 0.2 volt positive to the negative while charging at the normal rate."

It is best never to allow any organic matter or oxidizable substance to come into contact with the peroxide element of the battery. When cellulose is used, the effect is to convert it into grape sugar, which is decomposed. The latter is converted into plumbic formate and carbonate, sulphate being the ultimate product. It has been the author's experience that celluloid should be used very sparingly in cells, and never in connection with the positive plate, since its general tendency is towards decomposition. Others have found that when celluloid is used for forks and bearers, it soon becomes

<sup>1</sup> Storage Battery Engineering Practice, N. Y. E. E., Vol. 23, p. 454

coated with a shiny black coating, which is formed from the material itself.

It is always an easy matter to increase the capacity of a battery by mixing organic materials with the lead oxide; but, as any such mixture is always accompanied by a rapid deterioration of the plates, the increase in the capacity is concomitant with a decrease in the life. Besides this, those binding materials which are used to harden the plates are good as long as they are not decomposed by the current; but this decomposition will take place with every successive charge. It is evident that, unless an undecomposable body is formed with the lead oxides, the life of the plates will be greatly decreased. Many investigators have used manganese, either in the electrolyte or as a part of the active material, as peroxide of manganese. All trace of such compounds should be avoided, as the tendency is to reduce the capacity of the battery by carrying oxygen from the positive to the negative plate.

When filling the cells with acid, one cannot be too careful to have the acid of the proper strength; for, if too strong, the plates will be found to sulphate more rapidly, and the sulphate will be harder to reduce. It has been found that with plates 0.4 inch thick, the maximum capacity will be obtained when the acid is about 1.270 specific gravity, and with plates 0.25 inch thick, acid of 1.240 specific gravity.

Should the plates sulphate from any cause, it may be stopped and further prevented by using Urquhart's<sup>1</sup> remedy, which is made up as follows:

<sup>1</sup> Electric Light Fitting, J. W. Urquhart, p. 47.

To a quart of strong solution of common washing soda, add slowly, during agitation, 12 ounces of concentrated sulphuric acid. This should be added to the electrolyte in the proportion of 1 : 25.

Although the best modern practice is to use as the electrolyte nothing but the pure dilute acid, some investigators believe that if the electrolyte be either neutral or slightly alkaline, that the forming process will be much more rapid. To obtain this result, such salts of the light metals are used as will produce no decomposition on the positive electrode, and will therefore not interfere in any way with the formation of the peroxide. Luckow<sup>1</sup> is the originator of the above process.

In the manufacture of storage-battery plates, nearly every conceivable shape has been tried, and it has been found that an approximately square plate gives the best results. The plate should not be made too deep, else it will be subjected to different degrees of chemical action. Where the large central station plates are used,—approximately 15 × 30 inches in size,—some means have to be employed to keep the electrolyte of a uniform density. This is usually accomplished by means of a blast of air. As to the shape of the perforations, it has been already pointed out,<sup>2</sup> that that hole which is larger at the centre than it is at the surface, is the best. Many manufacturers believe that it is best to use some alloy of lead, which is unaffected by the chemical reactions which take place in the cell, thus allowing the plate to be more rigid and lighter in

<sup>1</sup> G. P., 84,423; 1894.

<sup>2</sup> *Vide* page 66.

weight than if constructed from pure lead. Mr. J. K. Pumpelly, however, believes that all alloys of lead should be avoided, and only chemically pure materials used. In this view he is supported by a constantly increasing number of manufacturers; in fact, it is now the exception to use alloys, except where the weight is an important factor.

The plate should be so constructed as to be able to expand with the active material, without destroying the contact between the two. The electrolyte should have free access to all parts of the active material; great porosity is therefore necessary. Zacharias<sup>1</sup> obtains this by pricking the active material with needles at the rate of about 100 holes per square decimetre. Many believe, notably among them Fitzgerald, that during the construction of the plates, it is best to make only the surface porous, so as not to sacrifice mechanical strength. Probably one of the potent causes for the destruction of the plates is the gas which is formed in the pores of the active material; the harder and denser the active material, the quicker will it be destroyed. It is for this reason that the negative plates are the most difficult to construct.

The contact between the active material and the conducting plate must be good; for if poor, a white sulphate will be formed at the surface, which practically forms an insulating layer. As pointed out by Mr. Hering, it is well to make the positive plates light, cheap, and easily replaceable. By this method, although the life will be shortened, the great difficulty caused by the

<sup>1</sup> G. P., 84,810; 1894.

gradual washing away of the peroxide will have been settled. When the perishable parts have been renewed, the battery is practically as good as new. This is the plan followed with the plates used in the Paris accumulator lines. The life will be soon known to the user, and he can readily determine for himself how much is to be allowed for amortization.

It has heretofore been the general custom among manufacturers to construct the end plates—of the perforated pasted type—like the other negatives, thus giving them twice the necessary surface and capacity. Although this decreases the internal resistance, it will be found that the end positives discharge more rapidly than they should, thus producing buckling. An easy way of overcoming this difficulty would be to punch the active material out of alternate meshes on the end plates, leaving the plates half empty and half full. Batteries which are constructed in this manner have been found to give excellent service. Plates of the Planté type, and of the grooved pasted type, are so constructed as to have half the capacity of the other negatives.

F. Zacharias<sup>1</sup> has come to the following conclusions concerning the manufacture and construction of plates :

1. No portion of the metallic frame should pass through the paste.
2. The paste should not be retained at the upper edge by the frame, but should be free to expand and to form gas.
3. Whenever the frame covers the active material, it should be perforated to allow the gas to escape.

<sup>1</sup> London Electrician, April 17, 1896.

4. The frame should distribute the current evenly, and have a minimum weight consistent with strength and securing the paste.

5. The frame should be so constructed that the material on the negative plates should not lose contact, even when disintegrated.

When it is desired to transport the battery to a distance, after having been in use, it should be taken apart, washed thoroughly, and the plates pressed together, so that only one face of each of the end ones is exposed to the air. Each batch is then wrapped in oiled paper. If it is not possible to do this, wrap each plate as much as possible with the oiled paper, and stuff the intervals between the plates with hay wrapped in oiled paper. The battery should be set up again as soon as possible, and then treated as though new.

If the battery is to remain idle for any considerable length of time, it should be first given a full charge at normal rates, and then given a recharge—till it commences to boil—at least once a week. If for any reason this recharge is impossible, the directions for the battery used should be followed.

If by any means the connections have become reversed, so that the negatives assume a chocolate color and the positives a slate color, the only remedy is to discharge the battery completely, so that the cell gives no E.M.F., or a very slight one. The connections are then changed, and the battery recharged; but slowly at first, as there is no counter E.M.F. to overcome.

When a battery has become run down, Trowbridge<sup>1</sup>

<sup>1</sup> A. P., 551,565; 1895.



charges it, removes the negative plates, and replaces them with zinc plates. The battery is then discharged, the zinc plates are removed, and the lead negatives replaced.

In connecting up cells, or on soldering connections to the plates, thin connections, and all connections made by soldering on the plate, should be avoided, where the electrolyte, falling below the joint, may expose it to the air, or to the action of electrolysis at the point where nascent oxygen or ozone is set free.

The relatively low conductivity of the peroxide must be considered; if the expansion is weak, cracks will be produced in which a white sulphate is formed. The distribution of current should therefore be uniform throughout the plate. The distance between each plate should be the same at all points, and the electrolyte should not be allowed to consist of layers of different densities. A frequent mistake is made in adding fresh acid when the specific gravity of the electrolyte has fallen, due to heavy sulphating. The cells should be given a prolonged charge instead. The addition of concentrated acid to the cell is liable to rot the grids.

Sir David Salomons,<sup>1</sup> in speaking of future improvements, says:

“There can be no doubt that the improvements in the future will take the form of a modified electrolyte, which, according to Mr. Robertson, must be of such a nature as to prevent the formation of or at once break up any deleterious substances which may be formed during the charge or discharge.” It must especially

<sup>1</sup> Electric Light Installations, Vol. 1, p. 105.

break up and prevent the formation of all those lead-trees, or fine lead-needles, which are the greatest trouble with the batteries at present.

It is also probable that batteries will be so constructed that the diffusivity of the acid will be greatly increased. Messrs. Gladstone and Hibbert, in a paper "On the Cause of the Changes of E.M.F. in Secondary Batteries," in Vol. 29 of the *London Electrician*, say :

"The fall of E.M.F. at the end of the discharge leaves a large percentage of active material unacted upon. This is mainly due to the weakness of the acid against the plates, on account of the interstices being much clogged, and it would be counteracted to considerable extent if the diffusion could be increased. When a cell has been discharged below its minimum useful voltage, there occurs the destructive action called scaling. This is probably due to the abnormal chemical action arising from very weak acid. Diffusion would prevent this.

## APPENDIX

### MEASUREMENT OF THE INTERNAL RESISTANCE OF A STORAGE CELL

SHELDON

In measuring the internal resistance of a storage battery by this method, see Fig. 114. Care should be taken to have the standard resistance nearly equal to that of

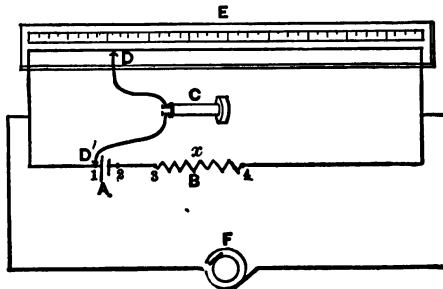

FIG. 114.

the accumulator to be tested; the Wheatstone bridge should have a resistance of about 10 ohms, or capable of carrying  $\frac{1}{2}$  of an ampere; and the alternator should give 10 or more amperes.

The contact  $D'$  should be placed successively at the points 1, 2, 3, and 4, and  $D$  shifted till the minimum sound is produced in the telephone. Calling  $a$ ,  $b$ ,  $c$ , and  $d$  the readings of the bridge wire for the points

1, 2, 3, and 4, respectively, and  $r$  the resistance of  $B$ , then

$$x = r \frac{a - b}{c - d}$$

#### MANCE'S METHOD, IMPROVED

This improvement, suggested by Dr. Perrin, is shown in Fig. 115. The resistance should be made equal to the normal load of the battery, so that the measurements are made under normal working conditions. A small resistance is also inserted in the galvanometer circuit.

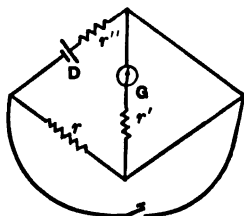

FIG. 115.

#### GRASSI'S METHOD

The following, which is given by Professor Grassi,<sup>1</sup> is a combination of Mance's improved method and the methods of Hopkinson and Mathieson.

In Fig. 116,  $x$  is the accumulator having an internal resistance  $x$ ;  $a, b, c, d$ , are four resistances, so determined

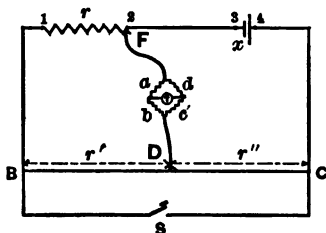

FIG. 116.

that  $bd = ac$ ,  $d$  being highly inductive;  $G$  is a galvanometer;  $r$ , a standard resistance;  $BC$ , a calibrated stretched wire; and  $D$ , a sliding contact.

In measuring the resistance, the wire  $F$  is connected successively to the terminals 1, 2, 3, and 4. For each connection, the position of  $D$  is adjusted until the

<sup>1</sup> L'Elettricista, May 1, 1895.

galvanometer remains at zero, when the switch  $S$  is opened and closed. Calling  $e, f, g,$  and  $h$  the readings on the calibrated wire  $BC$ , for the positions 1, 2, 3, and 4, we have for the resistance required

$$x = r \frac{h - g}{f - e}$$

#### MEASUREMENT OF THE E.M.F. OF A STORAGE CELL

Negrenau<sup>1</sup> gives the following method for measuring the E.M.F. of cells: "The current from a standard cell passes through a variable resistance  $r$  as far as the point  $a$  (see Fig. 117), where the circuit branches. The first branch contains a resistance  $r''$ , the other

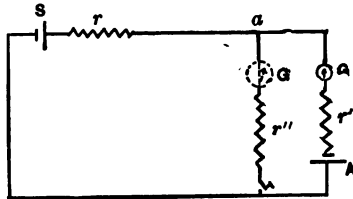

FIG. 117.

a galvanometer, a resistance  $r'$ , and a cell connected up in series to the standard cell. The resistances  $r$  and  $r'$  are adjusted till the galvanometer shows a constant deflection on opening and closing the first branch. The ratio of the E.M.F.'s is then given by the ratio of the two resistances."

Cosgrove improves this method by placing the galvanometer in the first branch. This gives a zero deflection on balance instead of a constant deflection, and readings can therefore be made with greater accuracy. This second method also has the advantage that a telephone receiver may be substituted for the galvanometer if convenient.

<sup>1</sup> E. W., Vol. 29, p. 739.

FORMULÆ FOR THE CALCULATION OF THE E.M.F. OF  
SECONDARY CELLS

In the following formula, from E. J. Wade's "Chemical Theory of Accumulators,"<sup>1</sup>

$W$  = the work in joules.

$Q$  = the coulombs of electricity that are passed through the electrolyte.

$H$  = the number of calories liberated by the recombination of a unit weight of one of the decomposed ions.

$e$  = its electro-chemical equivalent.

$c$  = its chemical equivalent.

$h$  = the electro-chemical equivalent of hydrogen  
= .00001038.

$J$  = Joule's coefficient = 4.2.

$E$  = the E.M.F. required.

$$W = QE,$$

$$W = QJeH;$$

therefore  $E = JeH$

and  $e = hc;$

therefore  $E = JhcH = 4.2 \times .00001038 cH$   
= .0000436  $cH$ .

Now,  $cH = \frac{\text{heat of formation}}{\text{valency}};$

therefore  $E = \frac{.0000436 \times \text{heat of formation}}{\text{valency}}$

<sup>1</sup> L. E., Vol. 33, p. 657.

Since nearly all the battery equations are expressed in terms of the transfer of two atoms of hydrogen, or their equivalent (that is, they are bivalent), and since

$$\frac{.0000436 \times 46,000}{2} = 1 \text{ volt,}$$

we have  $E = \frac{\text{heat of formation, in calories}}{46,000}$

In the application of the above law it should be remembered that the effects due to variations of the density of the electrolyte, allotropic modifications, and alterations in the state of the substances taking part in the reactions must be taken into account. Von Helmholtz claims that a temperature correction will also have to be applied, although from the result of some investigations that have been conducted by Preece, it would appear that the corrections are so small that it will not be necessary to take them into account.

Dr. Streintz<sup>1</sup> gives the following formula for the calculation of the E.M.F. of an accumulator:

$$E = 1.850 + 0.917 (S - s);$$

where

$S$  = the specific gravity of the electrolyte,

$s$  = the specific gravity of water at the temperature of observation, and

$E$  = the E.M.F. required.

<sup>1</sup> Zeit. für Electrotech., May 15, 1895.

FORMULA FOR THE CALCULATION OF THE CAPACITY OF  
A STORAGE BATTERY IN AMPERE-HOURS

It is well known that the current in ampere-hours maintained by the consumption of any given chemically active substance varies with the change of valence where oxidation and reduction occur, and inversely with the molecular weights of the transforming substance. The combustion or liberation of 1 pound of hydrogen corresponds to 12,160 ampere-hours.

The theoretical current capacity in ampere-hours may, therefore, be obtained as follows: Let

$V$  = the change of valence of the ions,

$W$  = the sum of the molecular weights affected, and

12,160 = the capacity per pound of hydrogen.

$$\text{Then capacity per pound} = \frac{12,160 \times V}{W}$$

Calling lead sulphate, which is the ultimate product at both electrodes, the real active material, we obtain by the use of the above formula 40.24 ampere-hours, or 80.48 watt-hours, per pound of lead sulphate, with the lead-lead-sulphuric-acid battery.

With the lead-zinc cell, the active working substance is both lead sulphate and zinc sulphate, and the theoretical capacity then obtained is 52.54 ampere-hours, or 126.1 watt-hours, per pound of active working substance.

Considering the positive and negative plates as equal, which they practically are, the capacity per pound of working substance on either plate alone would be 80.5



ampere-hours for the lead-lead-sulphuric-acid type, and 105.1 ampere-hours per pound for the lead-zinc type.

According to Monnier's and Guiton's estimate, it requires 565,600 coulombs to peroxidize 1 kilogramme of minium. As stated previously, Planté and Paget agree on 4.48 grammes of lead peroxide as the equivalent of 1 ampere-hour, and this corresponds to 0.158 ounce per ampere-hour. Fitzgerald has found 0.135 ounce per ampere-hour. This, it must be remembered, is the theoretical equivalent, on the supposition that all the active material on either plate is transformed into lead sulphate; that is, that the battery is completely discharged. As this is not accomplished, the best practice is to allow anywhere from 0.53 to 0.86 ounce of lead peroxide, and from 0.5 to 0.8 ounce of spongy lead to the ampere-hour, according to the discharge rate, thickness, and density. Fitzgerald gives as the safest rule, and the best practice bears him out, that a weight of 0.53 ounce per ampere-hour on each plate for a 10-hour rate, 0.6 ounce for a 5-hour rate, 0.7 ounce for a 3-hour rate, and 1.0 ounce for a 1-hour rate of discharge, for the ordinary thickness, and an electrolyte density of 1.200 will be found to afford the best results. While, of course, these rules are only approximate and will have to be modified for different plates and different conditions, it will be found that under ordinary circumstances it is perfectly safe to use the above values.

## THE STORAGE BATTERY

Name of Cell	Built for	Containing-Cell	Ampere-Hours per Pound of Element	Ampere-Hours per Pound of Cell, Complete	Weight in Pounds per Horse-Power-Hour	Energy Efficiency In %	Weight of Positive Active Material + Total Weight Positive Plate In %	Rate of Discharge in Hours	Average Voltage	Authority
American Battery . . .	L	R	4.10	2.4	162	...	...	3.5	...	Hering
American Battery . . .	L	G	...	2.2	178	...	...	7.5	...	Hering
Atlas . . .	L	R	9.60	6.2	60	...	53.5	10.0	...	Robertson
Austria . . .	L	G	12.00	8.4	45	...	...	20.0	...	Prospectus
Blot . . .	...	G	4.50	...	...	75	66.6	10.0	...	Margaine
Boettcher (Alka.-Zn) . . .	L	R	6.70	...	...	...	...	20.0	1.1	Prospectus
Bradbury-Stone . . .	L	G	1.92	1.5	250	...	...	2.0	...	Prospectus
Bradbury-Stone . . .	L	G	3.21	2.5	149	80	...	11.0	...	Prospectus
Brush . . .	L	G	1.50	...	...	...	...	4.0	...	...
Cély (Sarcia) . . .	L	G	1.50	...	...	...	...	10.0	...	Hering
Cheswright . . .	L	G	4.50	...	...	...	...	8.0	...	Prospectus
Commelin-Finot (Cd) . . .	...	G	2.92	...	...	...	...	20.0	2.3	Prospectus
Correns . . .	L	R	23.5	0.6	...	...	...	3.0	...	Kohlrausch
Correns . . .	L	R	...	1.1	...	...	...	3.0	...	Kohlrausch
Correns . . .	L	R	...	1.1	...	...	...	10.0	...	Kohlrausch
Correns . . .	L	R	...	1.6	...	...	...	10.0	...	Kohlrausch
Crompton-Howell . . .	L	G	...	1.9	226	85	...	2.5	...	Robertson
Desmazure . . .	...	G	...	19.	58	65	...	8.5	0.8	Prospectus
Drake & Gorham, D.-P. . . . .	...	G	...	3.0	131	...	...	11.0	...	Prospectus
Dujardin . . .	...	G	4.50	2.7	140	...	...	10.0	...	Prospectus
Electro-Chemical . . .	L	G	2.80	1.8	213	...	...	8.0	...	Chamberlain

Electro-Chemical . . . . .	L																	Chamberlain
Elec. S. B. Co. (Chlo.) . . . . .	L	2.10	1.4	278	71	3.0	7.0	189	71	2.1	7.0	Treadwell						
Elec. S. B. Co. (Chlo.) . . . . .	L	0.77	0.6	63	63	2.8	2.1	63	63	2.8	2.1	Treadwell						
Elec. S. B. Co. (Chlo.) . . . . .	L	3.9	3.9	69	69	3.7	3.7	69	69	3.7	3.7	E. W., 5-15-'97						
Elieson, Lamina . . . . .	L	5.10	3.5	126	80	10.0	10.0	126	80	10.0	10.0	Earle						
E. P. S., Plante type . . . . .	L	5.60	3.1	167	80	5.0	5.0	167	80	5.0	5.0	Earle						
E. P. S., Faure type . . . . .	L	4.90	2.3	328	80	7.0	7.0	328	80	7.0	7.0	May						
E. P. S., Faure type . . . . .	L	2.60	1.2	175	78	8.0	8.0	175	78	8.0	8.0	L. E., 11-3-'93						
E. P. S., Faure-King . . . . .	L	2.80	1.8	204	78	14.0	14.0	204	78	14.0	14.0	Gerald						
Epstein . . . . .	L	2.80	1.3	302	70	3.0	3.0	302	70	3.0	3.0	Gerald						
Faure . . . . .	L	2.80	1.3	302	70	3.0	3.0	302	70	3.0	3.0	} Langley and May-						
Faure . . . . .	L	2.80	1.3	302	70	3.0	3.0	302	70	3.0	3.0	berry						
Ford-Washburn . . . . .	T	3.26	1.9	226	72	slow	slow	226	72	slow	slow	Prospectus						
Ford-Washburn . . . . .	T	3.26	1.9	226	72	54.0	4.8	226	72	54.0	4.8	Hering						
Franklin . . . . .	T	2.25	1.3	348	72	6.7	6.7	348	72	6.7	6.7	Hering						
Franklin . . . . .	T	2.25	1.3	348	72	slow	slow	348	72	slow	slow	Prospectus						
Fulmen . . . . .	T	4.6	6.8	67	72	14.0	14.0	67	72	14.0	14.0	Prospectus						
Fulmen . . . . .	T	4.6	6.8	67	72	10.0	10.0	67	72	10.0	10.0	Prospectus						
Gadot . . . . .	T	3.20	1.4	262	72	12.0	12.0	262	72	12.0	12.0	Peukert						
Gadot . . . . .	T	3.20	1.4	262	72	3.0	3.0	262	72	3.0	3.0	Peukert						
Garassino . . . . .	T	6.10	4.1	93	72	50.0	50.0	93	72	50.0	50.0	Prospectus						
Gibson . . . . .	T	6.10	4.1	93	72	50.0	50.0	93	72	50.0	50.0	Prospectus						
Grünwald (Pb dust) . . . . .	T	3.20	3.20	93	72	65.0	65.0	93	72	65.0	65.0	Gethins						
Grünwald (Pb dust) . . . . .	T	3.20	3.20	93	72	65.0	65.0	93	72	65.0	65.0	Prospectus						
Grünwald (Pb dust) . . . . .	T	5.20	1.4	188	72	2.0	2.0	188	72	2.0	2.0	Prospectus						
Gülcher . . . . .	T	5.20	1.4	188	72	2.0	2.0	188	72	2.0	2.0	Prospectus						
Gülcher . . . . .	T	5.20	1.4	188	72	2.0	2.0	188	72	2.0	2.0	Prospectus						
Gülcher . . . . .	T	5.20	1.4	188	72	2.0	2.0	188	72	2.0	2.0	Prospectus						
Hagen . . . . .	T	3.3	3.3	188	72	12.0	12.0	188	72	12.0	12.0	Prospectus						
Hagen . . . . .	T	3.3	3.3	188	72	12.0	12.0	188	72	12.0	12.0	Prospectus						
Hagen . . . . .	T	3.3	3.3	188	72	12.0	12.0	188	72	12.0	12.0	Prospectus						
Hagen . . . . .	T	3.3	3.3	188	72	12.0	12.0	188	72	12.0	12.0	Prospectus						
Hatch . . . . .	T	2.1	3.1	129	72	12.0	12.0	129	72	12.0	12.0	Prospectus						
Hatch . . . . .	T	2.1	3.1	129	72	12.0	12.0	129	72	12.0	12.0	Prospectus						
Hatch . . . . .	T	2.1	3.1	129	72	12.0	12.0	129	72	12.0	12.0	Prospectus						
Hatch . . . . .	T	2.1	3.1	129	72	12.0	12.0	129	72	12.0	12.0	Prospectus						
Haus, D. J. . . . .	L	6.25	2.2	174	84	2.0	2.0	174	84	2.0	2.0	Houston & Kennelly						
Haus, D. J. . . . .	L	3.19	1.88	360	84	2.0	2.0	360	84	2.0	2.0	Kapp						
Haus, D. J. . . . .	L	1.88	1.3	360	84	2.0	2.0	360	84	2.0	2.0	Kapp						
Headland . . . . .	T	5.00	1.8	115	78	5.8	5.8	115	78	5.8	5.8	Kapp						
Hess . . . . .	T	3.13	1.8	115	78	5.8	5.8	115	78	5.8	5.8	Kapp						
Huber . . . . .	T	5.75	3.4	115	78	5.8	5.8	115	78	5.8	5.8	Kapp						

## THE STORAGE BATTERY

Name of Cell	Built for	Containing-Cell	Ampere-Hours per Pound of Element	Ampere-Hours per Pound of Cell, Complete	Weight in Pounds per Horse-Power-Hour	Energy Efficiency In %	Weight of Positive Active Material + Five Plates In %	Rate of Discharge in Hours	Average Voltage	Authority
Irving . . . . .	....	R	....	3.6	....	....	....	6.0	....	Robertson
Jacquet . . . . .	....	....	....	....	....	....	62.0	....	....	....
Julien . . . . .	T	R	6.70	4.3	87	80	....	8.5	....	....
Kabath, de . . . . .	....	....	5.70	4.8	86	....	....	slow	....	....
Khotimsky, de . . . . .	....	G	....	0.6	....	....	....	1.0	....	....
Legay . . . . .	T	R	....	3.1	133	....	....	1.0	....	Robertson
Lehman & Main . . . . .	....	....	....	1.2	....	....	....	3.0	....	....
Lehman & Main . . . . .	....	....	....	1.4	....	....	....	5.0	....	....
Lithanode, Fitzgerald . . . . .	....	....	8.40	4.9	76	....	90.0	slow	....	Lea
Lithanode, Frankland . . . . .	....	....	8.00	4.75	70	....	....	20.0	....	Forbes
Monnier . . . . .	....	G	3.44	2.3	....	....	....	6.3	....	Reynier
Montaud . . . . .	....	....	2.84	....	....	69	....	1.6	....	D'Arsonval
N. Y. Acc. & Elec. Co. . . . .	L	G	....	3.0	130	....	....	6.5	....	Prospectus
Niblett . . . . .	....	G	....	2.5	....	....	....	5.0	....	Prospectus
Ohio Stor. Bat. Co. . . . .	L	G	6.80	3.5	....	....	....	10.0	....	....
Peyrussou . . . . .	....	G	....	....	....	....	....	7.0	....	Robertson
Phillipart . . . . .	....	R	....	4.0	102	....	....	15.0	....	Prospectus
Phoenix . . . . .	....	G	6.68	....	....	....	....	....	....	Prospectus
Phoenix . . . . .	....	G	8.00	2.2	149	....	....	....	....	....
Planté . . . . .	L	G	4.52	1.1	396	72	....	....	....	Gerauld
Pollak . . . . .	L	G	4.15	3.9	107	80	....	7.5	....	E. W., 5-26-'94

Reynier (Elastic)	...	...	0.3	101	77	...	5.0	25.0	Robertson
Reynier (Pb-Zn)	...	6.90	4.1	112	...	...	6.0	2.4	Reynier
Reynier (Pb-Cu)	...	...	...	67	...	...	...	1.3	Prospectus
Ribbe	T	...	5.9	45	...	...	10.0	2.4	Riker
Riker	R	...	7.3	45	...	...	4.0	2.3	Riker
River & Rail	T	9.27	5.8	94	...	...	...	2.4	Prospectus
Roberts	T	...	3.8	90	...	...	3.0	...	Robertson
Rooney	L	3.20	2.5	157	70	57.0	8.7	...	Treadwell
Schaeffer-Heineman	T	4.04	1.0	...	...	...	0.5	...	Gibson
Schaeffer-Heineman	T	...	6.5	...	...	...	10.0	...	Gibson
Schanschieff	G	...	5.5	...	...	...	3.0	...	
Scheneck-Farbaky	G	1.79	2.2	178	70	...	4.7	...	Kohlrausch
Schoop (dry)	G	3.80	2.2	133	80	...	1.0	...	Kapp
Schoop (Oerlikon)	G	4.33	2.8	...	...	...	7.0	...	
Simmen-Reynier	...	3.32	act.	mat.	...	...	...	...	
Tauleigne	A. H.	per lb.	act.	...	...	...	...	1.4	Cosmos, 6-2-'96
Thercy-Oblasser	T	11.8	6.3	61	...	53.0	8.7	...	Everard
Tommassi (Multitub.)	L	2.72	2.2	195	...	...	10.0	...	Robertson
Tommassi (Multitub.)	L	1.99	1.5	278	80	67.7	2.8	...	Robertson
Tudor	L	1.90	1.5	250	80	67.0	11.0	...	
Tudor	L	0.96	0.8	...	...	67.0	1.0	...	Langley
Union S. B. Co.	L	5.46	3.4	120	...	...	5.0	...	Langley
Union S. B. Co.	L	10.9	6.7	54	...	...	25.0	...	
Verdier	T	14.5	5.2	...	...	...	13.0	...	
Waddell-Entz	...	See De smazur e	...	...	...	...	...	...	Prospectus
Willard	L	3.97	2.3	164	...	...	10.0	...	Prospectus
Willard	L	3.29	1.9	202	...	...	5.0	...	N. Y. E., 12-109
Winkler	L	3.78	...	...	...	37.0	...	...	Prospectus
Wüste-Rupprecht	T	...	5.5	...	...	...	8.0	...	
Wüste-Rupprecht	T	...	3.4	...	...	...	1.0	...	

NOTE. — Where the voltage is not given, it is the ordinary voltage of the lead cell; i. e. about 2 volts



# THE PRINCIPLES OF THE TRANSFORMER.

By **FREDERICK BEDELL, Ph.D.**,  
*Assistant Professor of Physics in Cornell University.*

**8vo. Cloth. 250 Illustrations. Price \$3.25, net.**

THIS work constitutes a systematic treatise on the Alternating Current Transformer, and a logical exposition of the principles involved, of the most modern methods of transformer design, construction, and testing, and of transformer systems of distribution. Portions of the book were originally prepared with the collaboration of Dr. A. C. Crehore. The work is suited for practical engineers and for students in electrical engineering; among the chapters are the following:

Transformer Systems of Distribution.  
The Magnetic Circuit of the Transformer.  
The Alternating Current.  
The Transformer Diagram.  
Simple Theory of the Transformer.  
Constant Current Transformer.

Constant Potential Transformer.  
Design and Construction.  
Experimental Transformer Diagrams.  
Instantaneous Transformer Curves.  
Transformer Testing.  
Effect of Hysteresis and Foucault Currents.

## OPINIONS OF THE PRESS.

"To gather all this into one book, and to formulate a definite and intelligible scheme out of the multifarious and often contradictory material at hand, was not an easy task, but the author has entirely succeeded. To the student and to the practical maker of transformers the work is invaluable."—*The Automotor*.

"The same clearness of reasoning and lucidity of style which has justly rendered the previous work [Bedell and Crehore's "Alternating Currents"] popular among students are apparent in this volume also."—*American Journal of Science*.

"Before its appearance the student was compelled to rely upon books which were illogical collections . . . hastily thrown together in book form. [One] should recognize the endeavor of Professor Bedell to bring order out of chaos in presenting the fundamental equations . . . in such a clear and instructive manner."

—PROFESSOR TROWBRIDGE, in *The Electrician*.

"While professedly exponent of the principles of the alternating current transformer, the author also deals with the practical sides of the question, both as regards manufacture and use. This part of the subject occupies the latter half of the volume; . . . the work should be of as much value to the English as to the American electrician."

—*Electricity*, London.

"The work is interesting and instructive, the style is very clear, and the various theories impartially examined; some good experimental diagrams are given, also useful information on testing transformers."—*Electrical Review*, London.

" . . . The special treatment of several problems is decidedly new. The author has not confined himself to the mathematical and graphical treatment of the subject, . . . but has incorporated many useful hints on the practical side of the subject. It is a valuable addition to the literature on transformers."—*The Electrical Engineer*, London.

THE MACMILLAN COMPANY,  
66 FIFTH AVENUE, NEW YORK.

# Alternating Currents and Alternating Current Machinery.

BY

**DUGALD E. JACKSON, M.E.,**

*Professor of Electrical Engineering in The University of Wisconsin*

AND

**JOHN PRICE JACKSON, M.E.,**

*Professor of Electrical Engineering in the Pennsylvania State College.*

**Cloth. 12mo. Price \$3.50, net.**

---

"It contains much important information not to be found elsewhere, and some which will be especially interesting to English readers, since it chiefly refers to American machinery."—*The Electrician*, London.

"The practical engineer will find in this volume an excellent reference book. There is no padding, the tables are modern, theory is simple, and the mathematics are not such as would stagger a person."

—*Wisconsin Engineer.*

"Students of Engineering and of that branch of the profession which has to do with the construction of alternating current machinery will welcome this addition to the literature on the subject of alternating currents. The student will find in this work a text-book and the engineer a book of reference."—*The Journal of the Franklin Institute.*

"It deserves favor from all electrical engineers, and especially from the higher electrical classes in scientific schools."—*Yale Scientific Monthly.*

"The book is up to date and conscientiously written. It may be read with the deepest satisfaction by any earnest student of electro-technics."

—*The Electric Age.*

"We believe that this is the only text-book on the subject worthy of the name, and it is, in our opinion, a matter of congratulation that the student has at last at his hand something adapted to his needs."

—*Electrical Engineer.*

---

**THE MACMILLAN COMPANY,**

**66 FIFTH AVENUE, NEW YORK.**